

**NEW**  
**PRODUCTS**  
**2020**

EDITION 3

## Recessed Spots Fixed



**10105R1** | 50W | MR16 | GU10 | Aluminium

new  
IP65





Order Code	Colour	Watts	Input	Class					Notes
10105R1/B	Black	50W	100-240V		15cm	68mm	120mm	50	-

## Recessed Spots Fixed LED

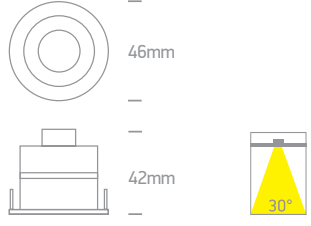

**10103M** | 3W | COB LED | Aluminium

new  
IP65





Order Code	Colour	Light Colour	CCT (K)	Watts	Lumen (lm)	Beam Angle	Input	Class					Notes
10103M/W/C	White	Cool white	4000K	3W	270lm	30°	700mA		60cm	38mm	55mm	50	Requires 700mA driver
10103M/W/W	White	Warm white	3000K	3W	270lm	30°	700mA		60cm	38mm	55mm	50	Requires 700mA driver
10103M/B/W	Black	Warm white	3000K	3W	270lm	30°	700mA		60cm	38mm	55mm	50	Requires 700mA driver



**10106V** | 6W | COB LED | Die cast + glass

new  
IP65





Order Code	Colour	Light Colour	CCT (K)	Watts	Lumen (lm)	Beam Angle	Input	Class				Notes
10106V/W/W	White	Warm white	3000K	6W	460lm	25°	100-240V		94mm	100mm	12	Complete with 500mA driver
10106V/B/W	Black	Warm white	3000K	6W	460lm	25°	100-240V		94mm	100mm	12	Complete with 500mA driver

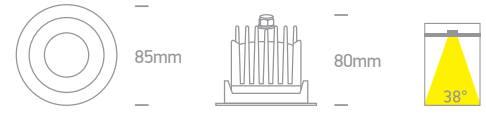
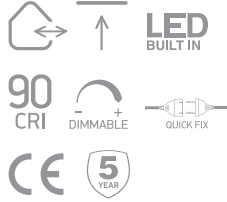

10110P | 12W | COB LED | Die cast

new  
DARK LIGHT  
IP65



A-A+ 10110P/W/W

10110P/W/C

Order Code	Colour	Light Colour	CCT (K)	Watts	Lumen (lm)	Beam Angle	Input	Class	⏏	⚡	⬆️	📦	Notes
10110P/W/C	White	Cool white	4000K	12W	1100lm	38°	700mA	⬡	40cm	75mm	110mm	48	Requires 700mA driver
10110P/W/W	White	Warm white	3000K	12W	1100lm	38°	700mA	⬡	40cm	75mm	110mm	48	Requires 700mA driver



10107DFV | 7W | SMD LED | Fire Rated | 3 Step Adjustable CCT | Metal + plastic

Complete with white ring.

new  
IP65

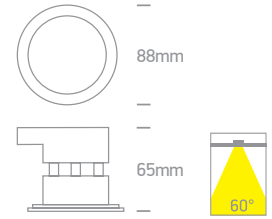
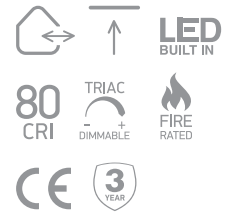

A-A+ 10107DFV/W

Order Code	Colour	Light Colour	CCT (K)	Watts	Lumen (lm)	Beam Angle	Input	Class	⏏	⚡	⬆️	📦	Notes
10107DFV/W	White	Extra warm white-Warm white-Cool white	2700K-3000K-4000K	7W	500lm	60°	230V	⬡	65mm	90mm	36	36	Complete with dimmable driver



50406C | 10W | SMD 3535 | Die cast

new  
DARK LIGHT  
IP20

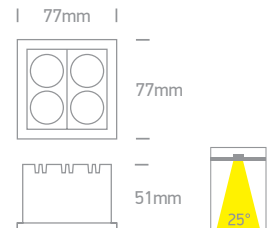
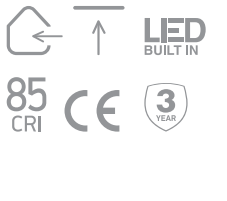

A-A+ 50406C/W/W

50406C/B/W

Order Code	Colour	Light Colour	CCT (K)	Watts	Lumen (lm)	Beam Angle	Input	Class	⏏	⬆️	📦	Notes
50406C/W/W	White	Warm white	3000K	10W	800lm	25°	230V	⬡	68x68mm	70mm	30	Complete with 700mA driver
50406C/B/W	Black	Warm white	3000K	10W	800lm	25°	230V	⬡	68x68mm	70mm	30	Complete with 700mA driver



50906C | 22W | SMD 3535 | Die cast

new  
DARK LIGHT  
IP20

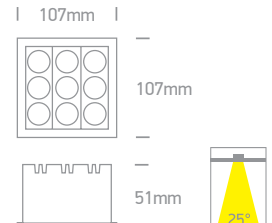
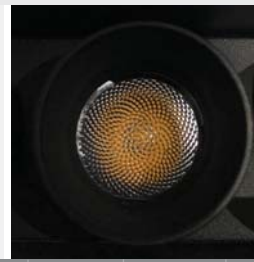
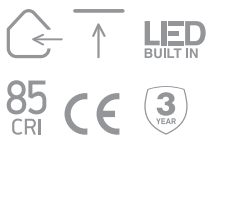

A-A+ 50906C/W/W

50906C/B/W

Order Code	Colour	Light Colour	CCT (K)	Watts	Lumen (lm)	Beam Angle	Input	Class	⏏	⬆️	📦	Notes
50906C/W/W	White	Warm white	3000K	22W	1760lm	25°	230V	⬡	96x96mm	70mm	18	Complete with 700mA driver
50906C/B/W	Black	Warm white	3000K	22W	1760lm	25°	230V	⬡	96x96mm	70mm	18	Complete with 700mA driver

## Recessed Spots Fixed LED

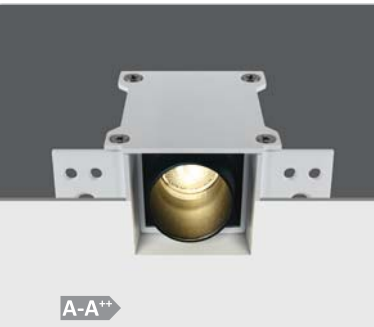

A-A<sup>++</sup>

**50103ATR** | 3W | SMD 3535 | Trimless | Die cast

**new**  
DARK LIGHT  
IP20

LED BUILT IN  
85 CRI  
CE  
3 YEAR

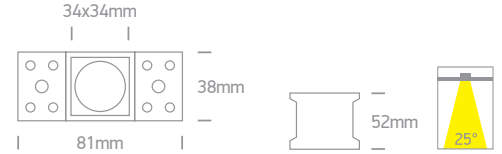

Order Code	Colour	Light Colour	CCT (K)	Watts	Lumen (lm)	Beam Angle	Input	Class				Notes
50103ATR/B/W	Black	Warm white	3000K	3W	200lm	25°	230V					50x38mm 70mm 50 Complete with 700mA driver



A-A<sup>++</sup>

**50203ATR** | 6W | SMD 3535 | Trimless | Die cast

**new**  
DARK LIGHT  
IP20

LED BUILT IN  
85 CRI  
CE  
3 YEAR

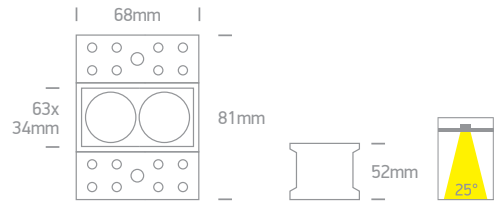

Order Code	Colour	Light Colour	CCT (K)	Watts	Lumen (lm)	Beam Angle	Input	Class				Notes
50203ATR/B/W	Black	Warm white	3000K	6W	480lm	25°	230V					68x50mm 70mm 40 Complete with 700mA driver

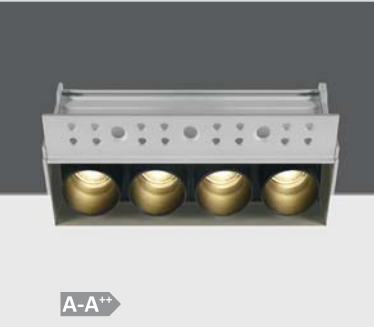

A-A<sup>++</sup>

**50403ATR** | 10W | SMD 3535 | Trimless | Die cast

**new**  
DARK LIGHT  
IP20

LED BUILT IN  
85 CRI  
CE  
3 YEAR

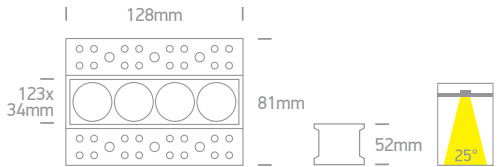

Order Code	Colour	Light Colour	CCT (K)	Watts	Lumen (lm)	Beam Angle	Input	Class				Notes
50403ATR/B/W	Black	Warm white	3000K	10W	800lm	25°	230V					128x50mm 70mm 20 Complete with 700mA driver

## Recessed Spots Adjustable LED



A-A<sup>++</sup>

**11112T** | 12W | COB LED | Trimless | Die cast

**new**  
DARK LIGHT  
IP20

LED BUILT IN  
80 CRI  
DIMMABLE  
QUICK FIX  
ADJUSTABLE  
CE  
3 YEAR

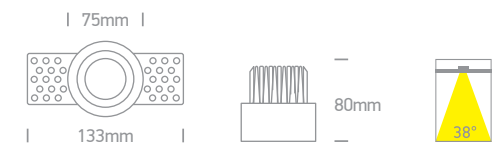

Order Code	Colour	Light Colour	CCT (K)	Watts	Lumen (lm)	Beam Angle	Input	Class				Notes
11112T/W/W	White	Warm white	3000K	12W	1100lm	38°	700mA					40cm 75mm 100mm 40 Requires 700mA driver



**10110CE** | 10W | SMD 4014 | Die cast + PC



**new**  
IP20



Adjustable cutout hole.



Order Code	Colour	Light Colour	CCT (K)	Watts	Lumen (lm)	Input	Class				Notes
<b>10110CE/C</b>	White	Cool white	4000K	10W	800lm	230V		60-100mm	40mm	100	Complete with 250mA driver
<b>10110CE/W</b>	White	Warm white	3000K	10W	800lm	230V		60-100mm	40mm	100	Complete with 250mA driver



**10114CE** | 14W | SMD 4014 | Die cast + PC

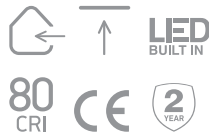

**new**  
IP20



Adjustable cutout hole.

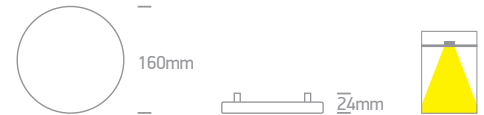

Order Code	Colour	Light Colour	CCT (K)	Watts	Lumen (lm)	Input	Class				Notes
<b>10114CE/C</b>	White	Cool white	4000K	14W	1200lm	230V		60-140mm	40mm	50	Complete with 300mA driver
<b>10114CE/W</b>	White	Warm white	3000K	14W	1200lm	230V		60-140mm	40mm	50	Complete with 300mA driver



**10120CE** | 20W | SMD 4014 | Die cast + PC

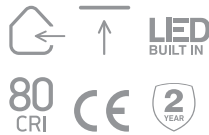

**new**  
IP20



Adjustable cutout hole.

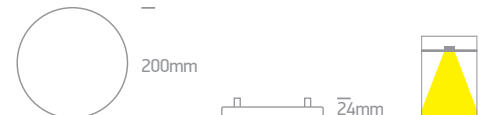

Order Code	Colour	Light Colour	CCT (K)	Watts	Lumen (lm)	Input	Class				Notes
<b>10120CE/C</b>	White	Cool white	4000K	20W	1700lm	230V		70-180mm	40mm	50	Complete with 700mA driver
<b>10120CE/W</b>	White	Warm white	3000K	20W	1700lm	230V		70-180mm	40mm	50	Complete with 700mA driver

Downlights Fixed LED



A-A+

new  
IP20

62116F | 16W | SMD 2835 | Surface / Recessed Mounted | Plastic



Adjustable cutout hole.



Order Code	Colour	Light Colour	CCT (K)	Watts	Lumen (lm)	Input	Class				Notes
62116F/W/C	White	Cool white	4000K	16W	1500lm	100-240V		70-175mm	50mm	20	Complete with 210mA driver
62116F/W/W	White	Warm white	3000K	16W	1500lm	100-240V		70-175mm	50mm	20	Complete with 210mA driver



A-A+

new  
IP20

62116FA | 16W | SMD 2835 | Surface / Recessed Mounted | Plastic



Adjustable cutout hole.



Order Code	Colour	Light Colour	CCT (K)	Watts	Lumen (lm)	Input	Class				Notes
62116FA/W/C	White	Cool white	4000K	16W	1500lm	100-240V		70-190mm	50mm	20	Complete with 230mA driver
62116FA/W/W	White	Warm white	3000K	16W	1500lm	100-240V		70-190mm	50mm	20	Complete with 230mA driver



11126F | 26W | COB LED | Die cast

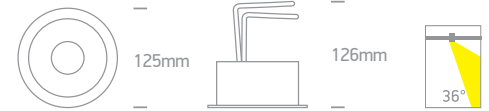
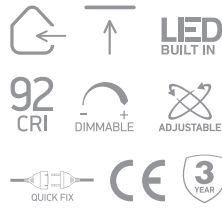

new  
IP20

A-A++

Order Code	Colour	Light Colour	CCT (K)	Watts	Lumen (lm)	Beam Angle	Input	Class				Notes
11126F/W/W	White	Warm white	3000K	26W	2210lm	36°	700mA		116mm	150mm	18	Requires 700mA driver



11113D | 13W | COB LED | Die cast

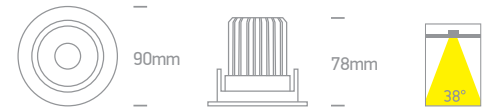
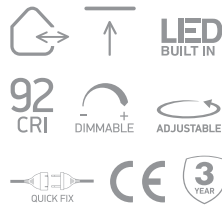

new  
DARK LIGHT  
IP54

A-A++

Order Code	Colour	Light Colour	CCT (K)	Watts	Lumen (lm)	Beam Angle	Input	Class				Notes
11113D/W/W	White	Warm white	3000K	13W	1100lm	38°	350mA		80mm	110mm	36	Requires 350mA driver



51130 | 30W | COB LED | Aluminium + metal

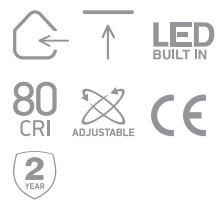

new  
IP20

A-A++

Order Code	Colour	Light Colour	CCT (K)	Watts	Lumen (lm)	Beam Angle	Input	Class				Notes
51130/W/W	White	Warm white	3000K	30W	2600lm	38°	230V		160x160mm	125mm	12	Complete with 750mA driver



51230 | 2x30W | COB LED | Aluminium + metal

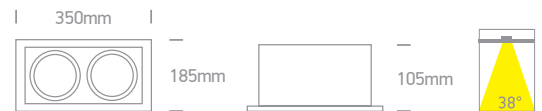
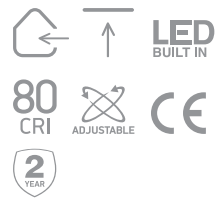

new  
IP20

A-A++

Order Code	Colour	Light Colour	CCT (K)	Watts	Lumen (lm)	Beam Angle	Input	Class				Notes
51230/W/W	White	Warm white	3000K	2x30W	2x2600lm	38°	230V		320x160mm	125mm	6	Complete with 750mA drivers

LED Strips & Profiles

 <p><b>A-A</b></p>		<b>7840A</b>   0,5W   2,5W/m   SMD 2835   Plastic					Modules for signs.		
		 <p>Supplied in 50pcs chain. Total length 10m.</p>		 <p>25mm 16mm 10mm</p>					
Order Code	Light Colour	CCT (K)	Watts	Lumen (lm)	Input	Class		Notes	
7840A/D	Daylight	6000K	0,5W	45lm	12V DC		50	Requires 12V DC driver	
 <p><b>A-A</b></p>		<b>7840B</b>   2x0,5W   5W/m   SMD 2835   Plastic					Modules for signs.		
		 <p>Supplied in 50pcs chain. Total length 10m.</p>		 <p>50mm 18mm 10mm</p>					
Order Code	Light Colour	CCT (K)	Watts	Lumen (lm)	Input	Class		Notes	
7840B/D	Daylight	6000K	1W	90lm	12V DC		30	Requires 12V DC driver	
 <p><b>A-A</b></p>		<b>7840C</b>   3x0,5W   7,5W/m   SMD 2835   Plastic					Modules for signs.		
		 <p>Supplied in 50pcs chain. Total length 10m.</p>		 <p>75mm 18mm 10mm</p>					
Order Code	Light Colour	CCT (K)	Watts	Lumen (lm)	Input	Class		Notes	
7840C/D	Daylight	6000K	1,5W	135lm	12V DC		20	Requires 12V DC driver	
 <p><b>A-A</b></p>		<b>7840D</b>   4x0,5W   10W/m   SMD 2835   Plastic					Modules for signs.		
		 <p>Supplied in 50pcs chain. Total length 10m.</p>		 <p>45mm 42mm 10mm</p>					
Order Code	Light Colour	CCT (K)	Watts	Lumen (lm)	Input	Class		Notes	
7840D/D	Daylight	6000K	2W	180lm	12V DC		20	Requires 12V DC driver	





7864/C

7864 | 9W/m | SMD 2835 | 120LEDs | PVC

Cut every 1m.

new  
IP65

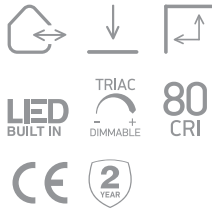

7864/W



7864C  
Connector + shrinking sleeve.



7864P  
230V Power supply 50m max.



7864F Fixing clip.



7864E End cup.

Order Code	Light Colour	CCT (K)	Watts	Lumen (lm)	Input	Class	Box	Notes
7864/C	Cool white	4000K	9W/m	270lm/m	230V		50m roll	Complete with 7864P power supply
7864/W	Warm white	3000K	9W/m	270lm/m	230V		50m roll	Complete with 7864P power supply

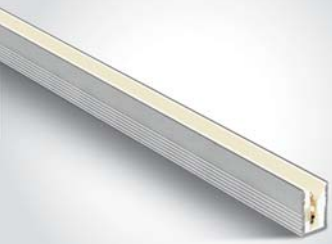

7901A/AL | 2m Surface profile | Aluminium | Suitable for 7841 LED Strip



new



Complete with 2 pairs end cups & 6pcs metal fixing clips.

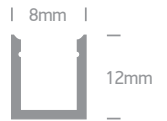

7901AR/AL | 2m Recessed profile | Aluminium | Suitable for 7841 LED Strip



new



Complete with 2 pairs end cups.

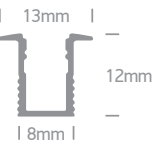
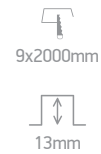

7920/B | 2m Step profile + PC opal diffuser | Aluminium | Suitable for 7820 LED Strips 8mm



new



Complete with 4pcs end cups.

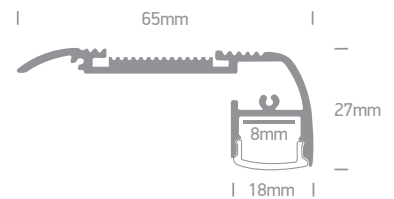

Track Spots



A-A\*\* 65654AT/W/W

65654AT | 20W | LED | Aluminium

**new**
  
**IP20**



65654AT/B/W

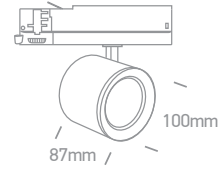

Order Code	Colour	Light Colour	CCT (K)	Watts	Lumen (lm)	Beam Angle	Input	Class		Notes
65654AT/W/C	White	Cool white	4000K	20W	1800lm	38°	230V		20	Complete with 450mA driver
65654AT/W/W	White	Warm white	3000K	20W	1800lm	38°	230V		20	Complete with 450mA driver
65654AT/B/C	Black	Cool white	4000K	20W	1800lm	38°	230V		20	Complete with 450mA driver
65654AT/B/W	Black	Warm white	3000K	20W	1800lm	38°	230V		20	Complete with 450mA driver



A-A\*\* 65654BT/W/W

65654BT | 30W | LED | Aluminium

**new**
  
**IP20**



65654BT/B/W

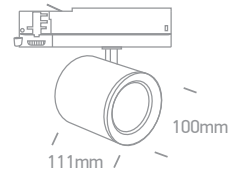

Order Code	Colour	Light Colour	CCT (K)	Watts	Lumen (lm)	Beam Angle	Input	Class		Notes
65654BT/W/C	White	Cool white	4000K	30W	2700lm	38°	230V		10	Complete with 750mA driver
65654BT/W/W	White	Warm white	3000K	30W	2700lm	38°	230V		10	Complete with 750mA driver
65654BT/B/C	Black	Cool white	4000K	30W	2700lm	38°	230V		10	Complete with 750mA driver
65654BT/B/W	Black	Warm white	3000K	30W	2700lm	38°	230V		10	Complete with 750mA driver



A-A\*\* 65654CT/W/W

65654CT | 40W | LED | Aluminium

**new**
  
**IP20**



65654CT/B/W

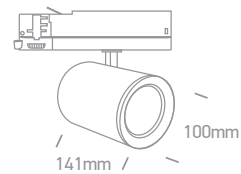

Order Code	Colour	Light Colour	CCT (K)	Watts	Lumen (lm)	Beam Angle	Input	Class		Notes
65654CT/W/C	White	Cool white	4000K	40W	3600lm	38°	230V		10	Complete with 1050mA driver
65654CT/W/W	White	Warm white	3000K	40W	3600lm	38°	230V		10	Complete with 1050mA driver
65654CT/B/C	Black	Cool white	4000K	40W	3600lm	38°	230V		10	Complete with 1050mA driver
65654CT/B/W	Black	Warm white	3000K	40W	3600lm	38°	230V		10	Complete with 1050mA driver



A-A+ 65654CTT/W/W

new  
IP20

65654CTT | 40W | LED | Dimmable | Aluminium

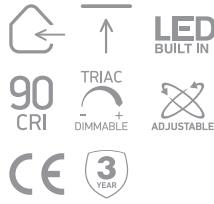

65654CTT/B/W

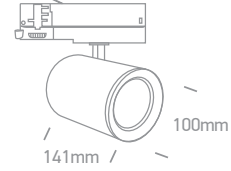

Order Code	Colour	Light Colour	CCT (K)	Watts	Lumen (lm)	Beam Angle	Input	Class	Box	Notes
65654CTT/W/C	White	Cool white	4000K	40W	3600lm	38°	230V	□	10	Complete with 900mA dimmable driver
65654CTT/W/W	White	Warm white	3000K	40W	3600lm	38°	230V	□	10	Complete with 900mA dimmable driver
65654CTT/B/C	Black	Cool white	4000K	40W	3600lm	38°	230V	□	10	Complete with 900mA dimmable driver
65654CTT/B/W	Black	Warm white	3000K	40W	3600lm	38°	230V	□	10	Complete with 900mA dimmable driver



A-A+ 65650AT/W/W

new  
IP20

65650AT | 15W | COB LED | Adjustable beam 20°-60° | Aluminium

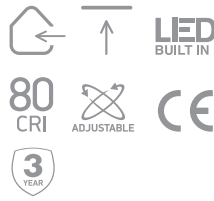

65650AT/B/W

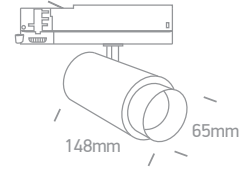

Order Code	Colour	Light Colour	CCT (K)	Watts	Lumen (lm)	Beam Angle	Input	Class	Box	Notes
65650AT/W/W	White	Warm white	3000K	15W	1350lm	20°-60°	230V	□	15	Complete with 400mA driver
65650AT/B/W	Black	Warm white	3000K	15W	1350lm	20°-60°	230V	□	15	Complete with 400mA driver

Track Spots



A-A\*\* 65656AT/W/W

65656AT | 6W | SMD 5050 | Aluminium

new  
DARK LIGHT  
IP20

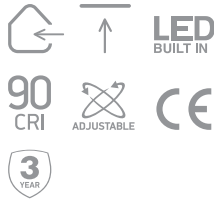

65656AT/B/W

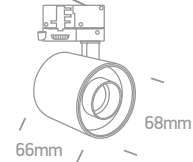

Order Code	Colour	Light Colour	CCT (K)	Watts	Lumen (lm)	Beam Angle	Input	Class	⊞	Notes
65656AT/W/W	White	Warm white	3000K	6W	480lm	40°	230V	⊞	28	Complete with 150mA driver
65656AT/B/W	Black	Warm white	3000K	6W	480lm	40°	230V	⊞	28	Complete with 150mA driver



A-A\*\* 65656BT/W/W

65656BT | 12W | SMD 5050 | Aluminium

new  
DARK LIGHT  
IP20

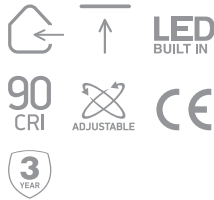

65656BT/B/W

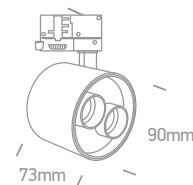

Order Code	Colour	Light Colour	CCT (K)	Watts	Lumen (lm)	Beam Angle	Input	Class	⊞	Notes
65656BT/W/W	White	Warm white	3000K	12W	960lm	40°	230V	⊞	20	Complete with 350mA driver
65656BT/B/W	Black	Warm white	3000K	12W	960lm	40°	230V	⊞	20	Complete with 350mA driver



A-A\*\* 65656CT/W/W

65656CT | 24W | SMD 5050 | Aluminium

new  
DARK LIGHT  
IP20

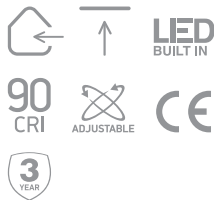

65656CT/B/W

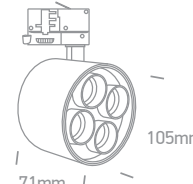

Order Code	Colour	Light Colour	CCT (K)	Watts	Lumen (lm)	Beam Angle	Input	Class	⊞	Notes
65656CT/W/W	White	Warm white	3000K	24W	1920lm	40°	230V	⊞	20	Complete with 700mA driver
65656CT/B/W	Black	Warm white	3000K	24W	1920lm	40°	230V	⊞	20	Complete with 700mA driver



A-A\*\* 65656DT/W/W

65656DT | 36W | SMD 5050 | Aluminium

new  
DARK LIGHT  
IP20

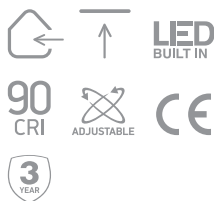

65656DT/B/W

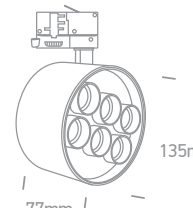

Order Code	Colour	Light Colour	CCT (K)	Watts	Lumen (lm)	Beam Angle	Input	Class	⊞	Notes
65656DT/W/W	White	Warm white	3000K	36W	2880lm	40°	230V	⊞	15	Complete with 1000mA driver
65656DT/B/W	Black	Warm white	3000K	36W	2880lm	40°	230V	⊞	15	Complete with 1000mA driver



A-A\*\* 65406BT/W/W

65406BT | 15W | LED | Die cast

new  
IP20

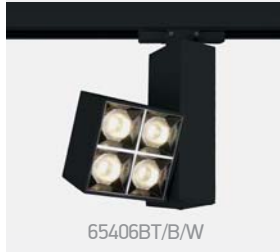
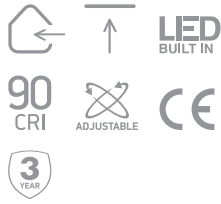

65406BT/B/W

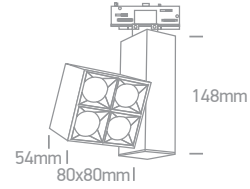

Order Code	Colour	Light Colour	CCT (K)	Watts	Lumen (lm)	Beam Angle	Input	Class	Box	Notes
65406BT/W/W	White	Warm white	3000K	15W	1200lm	38°	230V	⊕	24	Complete with 350mA driver
65406BT/B/W	Black	Warm white	3000K	15W	1200lm	38°	230V	⊕	24	Complete with 350mA driver



A-A\*\* 65906BT/W/W

65906BT | 30W | LED | Die cast

new  
IP20

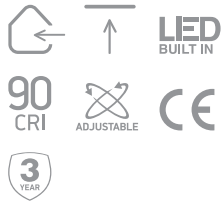

65906BT/B/W

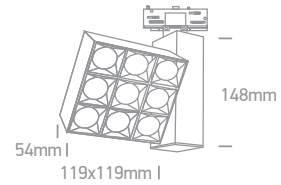

Order Code	Colour	Light Colour	CCT (K)	Watts	Lumen (lm)	Beam Angle	Input	Class	Box	Notes
65906BT/W/W	White	Warm white	3000K	30W	2400lm	38°	230V	⊕	16	Complete with 700mA driver
65906BT/B/W	Black	Warm white	3000K	30W	2400lm	38°	230V	⊕	16	Complete with 700mA driver



A-A\*\* 65040T/B/C

65040T | 40W | COB LED | Aluminium

new  
IP20

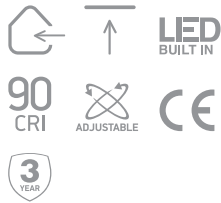

65040T/W/C

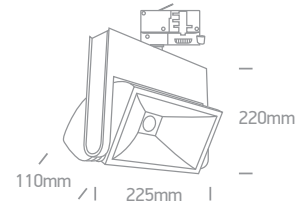

Order Code	Colour	Light Colour	CCT (K)	Watts	Lumen (lm)	Beam Angle	Input	Class	Box	Notes
65040T/W/C	White	Cool white	4000K	40W	3600lm	60°	230V	⊕	6	Complete with 1050mA driver
65040T/B/C	Black	Cool white	4000K	40W	3600lm	60°	230V	⊕	6	Complete with 1050mA driver

Track Spots



**65170AT** | 30W | SMD3030 | Linear track light | Aluminium



**new**  
IP20



65170AT/W/W

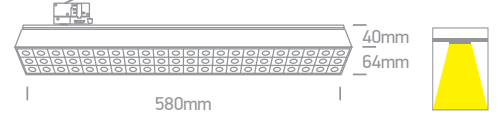

A-A\*\* 65170AT/B/W

Order Code	Colour	Light Colour	CCT (K)	Watts	Lumen (lm)	Input	Class	Box	Notes
65170AT/W/C	White	Cool white	4000K	30W	2700lm	230V	⊥	12	Complete with 700mA driver
65170AT/W/W	White	Warm white	3000K	30W	2700lm	230V	⊥	12	Complete with 700mA driver
65170AT/B/C	Black	Cool white	4000K	30W	2700lm	230V	⊥	12	Complete with 700mA driver
65170AT/B/W	Black	Warm white	3000K	30W	2700lm	230V	⊥	12	Complete with 700mA driver



**65170BT** | 60W | SMD3030 | Linear track light | Aluminium



**new**  
IP20



65170BT/W/W

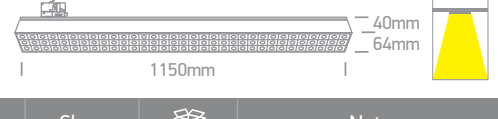

A-A\*\* 65170BT/B/W

Order Code	Colour	Light Colour	CCT (K)	Watts	Lumen (lm)	Input	Class	Box	Notes
65170BT/W/C	White	Cool white	4000K	60W	5400lm	230V	⊥	12	Complete with 1500mA driver
65170BT/W/W	White	Warm white	3000K	60W	5400lm	230V	⊥	12	Complete with 1500mA driver
65170BT/B/C	Black	Cool white	4000K	60W	5400lm	230V	⊥	12	Complete with 1500mA driver
65170BT/B/W	Black	Warm white	3000K	60W	5400lm	230V	⊥	12	Complete with 1500mA driver



**65105GT** | 10W | MR16 | GU10 | Polycarbonate



**new**  
IP20

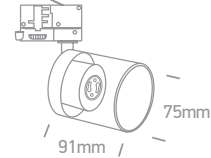

A-A\*\*

Order Code	Colour	Watts	Input	Class	Box	Notes
65105GT	Clear	10W	100-240V	⊥	40	-



A-A+ 65105C/W

**65105C | 10W | MR16 | GU10 | Aluminium**

new  
DARK LIGHT  
IP20

CE 5 YEAR

ADJUSTABLE

65105C/B

Complete with Black & Brass reflectors.

Order Code	Colour	Watts	Input	Class		Notes
65105C/W	White	10W	100-240V	⊕	40	-
65105C/B	Black	10W	100-240V	⊕	40	-



A-A+ 65105C/BBS

**65105C | 10W | MR16 | GU10 | Aluminium**

new  
DARK LIGHT  
IP20

CE 5 YEAR

ADJUSTABLE

65105C/BBS

Order Code	Colour	Watts	Input	Class		Notes
65105C/BBS	Brushed brass	10W	100-240V	⊕	40	-



A-A+ 65105BT/W

**65105BT | 10W | MR16 | GU10 | Aluminium**

new  
DARK LIGHT  
IP20

CE 5 YEAR

ADJUSTABLE

65105BT/B

Order Code	Colour	Watts	Input	Class		Notes
65105BT/W	White	10W	100-240V	⊕	30	-
65105BT/B	Black	10W	100-240V	⊕	30	-



A-A+ 65105WT/W

**65105WT | 10W | MR16 | GU10 | Aluminium**

new  
DARK LIGHT  
IP20

CE 5 YEAR

ADJUSTABLE

65105WT/B

Order Code	Colour	Watts	Input	Class		Notes
65105WT/W	White	10W	100-240V	⊕	30	-
65105WT/B	Black	10W	100-240V	⊕	30	-

Tracks



**40003R** | 16A | 3m Recessed track | 3-phase | Aluminium



new

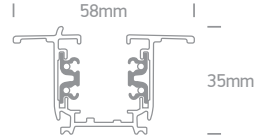
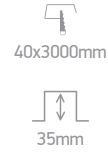

Order Code	Colour	Input	Ampere	Class		Notes
40003R/W	White	100-240V	16A		10	-



**41004B** | Cover for 41004A | Plastic



new

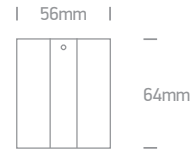

10



**41008B** | Cover for 41010A | Plastic



new

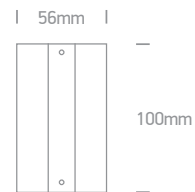

10



**41012B** | Cover for corner 41012A | Plastic



new

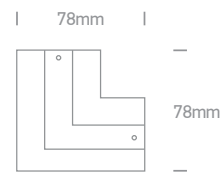

10



**41016B** | Cover for T connector 41016A | Plastic



new

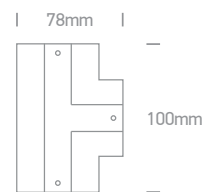

10





40020/W

**40020** | 2m Profile for square tracks 40002A & 40003A | Aluminium



new



40020/B

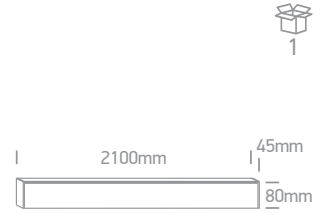
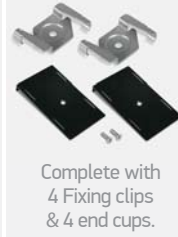

40002C/W

**40002C** | 2m Plastic cover for square tracks 40002A & 40003A



new



40002C/B



40002A/B + 40002C/B

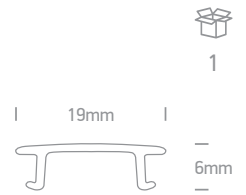

Office & Kitchen



A-A<sup>++</sup> 38148N/C

**38148N** | 48W | SMD 2835 | Aluminium + PC



new

IP20



38148N/W

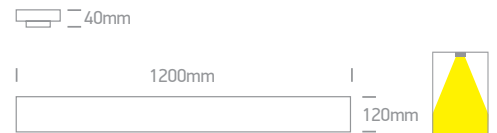

Order Code	Colour	Light Colour	CCT (K)	Watts	Lumen (lm)	Input	Class		Notes
38148N/C	White	Cool white	4000K	48W	4800lm	230V		4	Complete with driver
38148N/W	White	Warm white	3000K	48W	4800lm	230V		4	Complete with driver



A-A++ 38145AR/B/W

**38145AR** | 40W | SMD 2835 | Recessed linear system | Aluminium

Can be connected in line.

new  
IP20

80 CRI  
UGR19

LED BUILT IN  
CE  
3 YEAR



38145AR/W/W



Complete with 6pcs fixing clips, 4pcs connectors & 2pcs end cups.

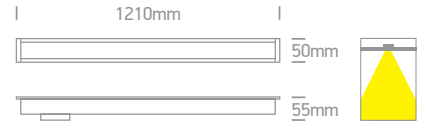

Order Code	Colour	Light Colour	CCT (K)	Watts	Lumen (lm)	Input	Class	⚡	↕	📦	Notes
38145AR/W/C	White	Cool white	4000K	40W	3800lm	230V	⊕	1200x37mm	80mm	12	Complete with 1000mA driver
38145AR/W/W	White	Warm white	3000K	40W	3800lm	230V	⊕	1200x37mm	80mm	12	Complete with 1000mA driver
38145AR/B/C	Black	Cool white	4000K	40W	3800lm	230V	⊕	1200x37mm	80mm	12	Complete with 1000mA driver
38145AR/B/W	Black	Warm white	3000K	40W	3800lm	230V	⊕	1200x37mm	80mm	12	Complete with 1000mA driver



A-A++ 38145BR/W/C

**38145BR** | 40W | SMD 3030 | Recessed linear system | Aluminium

Can be connected in line.

new  
DARK LIGHT  
IP20

80 CRI  
UGR19

LED BUILT IN  
CE  
3 YEAR



38145BR/W/W



Complete with 6pcs fixing clips, 4pcs connectors & 2pcs end cups.

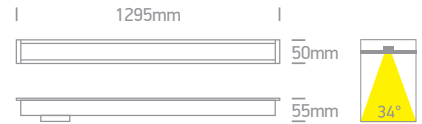

Order Code	Colour	Light Colour	CCT (K)	Watts	Lumen (lm)	Beam Angle	Input	Class	⚡	↕	📦	Notes
38145BR/W/C	White	Cool white	4000K	40W	4000lm	34°	230V	⊕	1280x37mm	80mm	12	Complete with 1000mA driver
38145BR/W/W	White	Warm white	3000K	40W	4000lm	34°	230V	⊕	1280x37mm	80mm	12	Complete with 1000mA driver

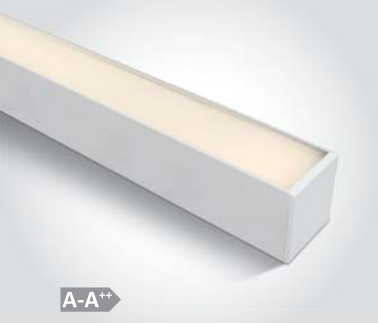

A-A++

**38160A** | 40W | SMD 2835 | Linear system | Diffuser | Aluminium

Can be connected in line.

new  
IP20

80 CRI  
UGR19

LED BUILT IN  
CE  
3 YEAR



Complete with 4 Fixing clips & 4 connectors.



Optional suspension kit. Order code 050170.



Order Code	Colour	Light Colour	CCT (K)	Watts	Lumen (lm)	Input	Class	⚡	📦	Notes
38160A/W/C	White	Cool white	4000K	40W	3400lm	230V	⊕	300cm	12	Complete with 1000mA driver
38160A/W/W	White	Warm white	3000K	40W	3400lm	230V	⊕	300cm	12	Complete with 1000mA driver
38160A/B/C	Black	Cool white	4000K	40W	3400lm	230V	⊕	300cm	12	Complete with 1000mA driver
38160A/B/W	Black	Warm white	3000K	40W	3400lm	230V	⊕	300cm	12	Complete with 1000mA driver



**A-A<sup>++</sup>** 12105E4/B

**12105E4** | 10W | MR16 | GU10 | Aluminium

**new**

DARK LIGHT

IP20



↑

←

ADJUSTABLE



5 YEAR



12105E4/W





Order Code	Colour	Watts	Input	Class		Notes
12105E4/W	White	10W	100-240V		30	-
12105E4/B	Black	10W	100-240V		30	-

Wall & Ceiling LED



**67480A** | 6W | COB LED | Die cast

new  
IP65

80 CRI  
IK06  
LED BUILT IN  
CE  
2 YEAR



Order Code	Colour	Light Colour	CCT (K)	Watts	Lumen (lm)	Input	Class		Notes
67480A/AN/W	Anthracite	Warm white	3000K	6W	480lm	230V		8	Complete with 500mA driver



**67480B** | 2x6W | COB LED | Die cast

new  
IP65

80 CRI  
IK06  
LED BUILT IN  
CE  
2 YEAR





Order Code	Colour	Light Colour	CCT (K)	Watts	Lumen (lm)	Input	Class		Notes
67480B/AN/W	Anthracite	Warm white	3000K	2x6W	960lm	230V		8	Complete with 500mA driver



**67492** | 12W | SMD 2835 | Plastic + PC

new  
IP54

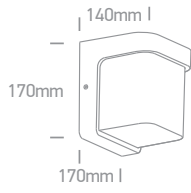
80 CRI  
LED BUILT IN  
CE  
2 YEAR

Order Code	Colour	Light Colour	CCT (K)	Watts	Lumen (lm)	Input	Class		Notes
67492/AN/W	Anthracite	Warm white	3000K	12W	600lm	230V		12	Complete with 300mA driver



**67492P** | 12W | SMD 2835 | Sensor | Plastic + PC

new  
IP54

80 CRI  
LED BUILT IN  
CE  
2 YEAR

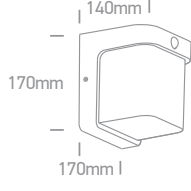
Order Code	Colour	Light Colour	CCT (K)	Watts	Lumen (lm)	Input	Class		Notes
67492P/AN/W	Anthracite	Warm white	3000K	12W	600lm	230V		12	Complete with 300mA driver



A-A+ 67484/W/W

67484 | 6W | AC LED | Die cast

new  
IP65

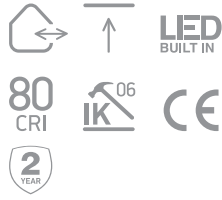

67484/B/W



Order Code	Colour	Light Colour	CCT (K)	Watts	Lumen (lm)	Input	Class		Notes
67484/W/W	White	Warm white	3000K	6W	480lm	230V		12	AC LED
67484/B/W	Black	Warm white	3000K	6W	480lm	230V		12	AC LED



67478/W/W

67478 | 12W | SMD 2835 | Die cast + PC

new  
DARK LIGHT  
IP65

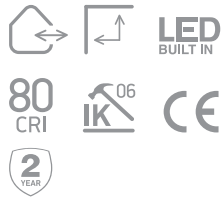

67478/B/W



Order Code	Colour	Light Colour	CCT (K)	Watts	Lumen (lm)	Input	Class		Notes
67478/W/W	White	Warm white	3000K	12W	325lm	230V		6	Complete with 300mA driver
67478/B/W	Black	Warm white	3000K	12W	325lm	230V		6	Complete with 300mA driver



A-A+ IP20

24002 | 30W LED | 35W FAN | 6 Speed Fan | Plastic

DC Motor.

new  
IP20

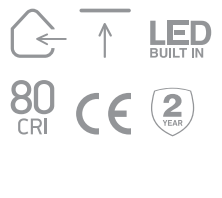

Complete with remote control.

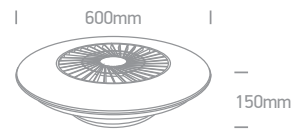

Order Code	Colour	Light Colour	CCT (K)	Watts	Lumen (lm)	Input	Class		Notes
24002/W	White	Warm white-Cool white-Daylight	3000K-4000K-6000K	30W LED / 35W FAN	2600lm	230V		1	-

Wall & Ceiling LED



**12406C** | 10W | SMD 3535 | Aluminium

**new**  
DARK LIGHT  
IP20

85 CRI CE 3 YEAR LED BUILT IN



64mm | 64mm | 84mm



Order Code	Colour	Light Colour	CCT (K)	Watts	Lumen (lm)	Beam Angle	Input	Class		Notes
12406C/W/W	White	Warm white	3000K	10W	800lm	25°	230V		40	Complete with 700mA driver
12406C/B/W	Black	Warm white	3000K	10W	800lm	25°	230V		40	Complete with 700mA driver



**12606C** | 15W | SMD 3535 | Aluminium

**new**  
DARK LIGHT  
IP20

85 CRI CE 3 YEAR LED BUILT IN



35mm | 185mm | 84mm



Order Code	Colour	Light Colour	CCT (K)	Watts	Lumen (lm)	Beam Angle	Input	Class		Notes
12606C/W/W	White	Warm white	3000K	15W	1200lm	25°	230V		30	Complete with 700mA driver
12606C/B/W	Black	Warm white	3000K	15W	1200lm	25°	230V		30	Complete with 700mA driver



**12906C** | 20W | SMD 3535 | Aluminium

**new**  
DARK LIGHT  
IP20

85 CRI CE 3 YEAR LED BUILT IN



95mm | 95mm | 84mm



Order Code	Colour	Light Colour	CCT (K)	Watts	Lumen (lm)	Beam Angle	Input	Class		Notes
12906C/W/W	White	Warm white	3000K	20W	1600lm	25°	230V		20	Complete with 700mA driver
12906C/B/W	Black	Warm white	3000K	20W	1600lm	25°	230V		20	Complete with 700mA driver



A-A+ 62182/BAN/W

62182 | 40W | SMD 2835 | Aluminium

new

IP20



62182/BBS/W



62182/BBR/W

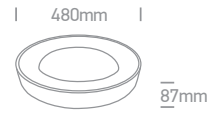

Order Code	Colour	Light Colour	CCT (K)	Watts	Lumen (lm)	Input	Class		Notes
62182/BAN/W	Brushed anthracite	Warm white	3000K	40W	2400lm	230V		1	Complete with 1050mA driver
62182/BBS/W	Brushed brass	Warm white	3000K	40W	2400lm	230V		1	Complete with 1050mA driver
62182/BBR/W	Brushed brown	Warm white	3000K	40W	2400lm	230V		1	Complete with 1050mA driver



A-A+ 62182A/BAN/W

62182A | 50W | SMD 2835 | Aluminium

new

IP20



62182A/BBS/W



62182A/BBR/W



Order Code	Colour	Light Colour	CCT (K)	Watts	Lumen (lm)	Input	Class		Notes
62182A/BAN/W	Brushed anthracite	Warm white	3000K	50W	3000lm	230V		1	Complete with 1300mA driver
62182A/BBS/W	Brushed brass	Warm white	3000K	50W	3000lm	230V		1	Complete with 1300mA driver
62182A/BBR/W	Brushed brown	Warm white	3000K	50W	3000lm	230V		1	Complete with 1300mA driver



A-A+ 62130L/W/W

62130L | 30W | SMD 2835 | Aluminium

new

IP20



62130L/B/W



62130L/BBS/W



Order Code	Colour	Light Colour	CCT (K)	Watts	Lumen (lm)	Input	Class		Notes
62130L/W/W	White	Warm white	3000K	30W	1800lm	230V		1	Complete with 750mA driver
62130L/B/W	Black	Warm white	3000K	30W	1800lm	230V		1	Complete with 750mA driver
62130L/BBS/W	Brushed brass	Warm white	3000K	30W	1800lm	230V		1	Complete with 750mA driver



A-A+ 62148L/W/W

62148L | 48W | SMD 2835 | Aluminium

new

IP20



62148L/B/W



62148L/BBS/W



Order Code	Colour	Light Colour	CCT (K)	Watts	Lumen (lm)	Input	Class		Notes
62148L/W/W	White	Warm white	3000K	48W	2880lm	230V		1	Complete with 1200mA driver
62148L/B/W	Black	Warm white	3000K	48W	2880lm	230V		1	Complete with 1200mA driver
62148L/BBS/W	Brushed brass	Warm white	3000K	48W	2880lm	230V		1	Complete with 1200mA driver

Plafó

**62112** | 12W | SMD 2835 | Aluminium

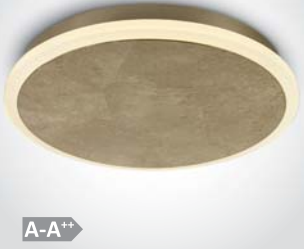

A-A++

new  
IP20

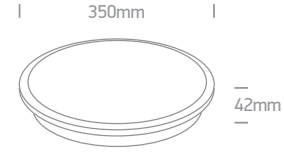

Order Code	Colour	Light Colour	CCT (K)	Watts	Lumen (lm)	Input	Class			Notes
62112/BS/W	Brass	Warm white	3000K	12W	960lm	230V			1	Complete with 24V DC driver

**62116F** | 16W | SMD 2835 | Surface / Recessed Mounted | Plastic



A-A++

new  
IP20



Adjustable cutout hole.



Order Code	Colour	Light Colour	CCT (K)	Watts	Lumen (lm)	Input	Class				Notes	
62116F/W/C	White	Cool white	4000K	16W	1500lm	100-240V			70-175mm	50mm	20	Complete with 210mA driver
62116F/W/W	White	Warm white	3000K	16W	1500lm	100-240V			70-175mm	50mm	20	Complete with 210mA driver

**62116FA** | 16W | SMD 2835 | Surface / Recessed Mounted | Plastic



A-A++

new  
IP20



Adjustable cutout hole.



Order Code	Colour	Light Colour	CCT (K)	Watts	Lumen (lm)	Input	Class				Notes	
62116FA/W/C	White	Cool white	4000K	16W	1500lm	100-240V			70-190mm	50mm	20	Complete with 230mA driver
62116FA/W/W	White	Warm white	3000K	16W	1500lm	100-240V			70-190mm	50mm	20	Complete with 230mA driver



**38114M** | 15W | SMD 2835 | Aluminium + PC



new  
IP44

A-A

Order Code	Colour	Light Colour	CCT (K)	Watts	Lumen (lm)	Input	Class		Notes
<b>38114M/C</b>	Chrome	Cool white	4000K	15W	1200lm	230V	⊕	12	Complete with 130mA driver
<b>38114M/W</b>	Chrome	Warm white	3000K	15W	1200lm	230V	⊕	12	Complete with 130mA driver

**38114MA** | 16W | SMD 2835 | Aluminium + PC



new  
IP44

A-A

Order Code	Colour	Light Colour	CCT (K)	Watts	Lumen (lm)	Input	Class		Notes
<b>38114MA/C</b>	Chrome	Cool white	4000K	16W	1300lm	230V	⊕	12	Complete with 120mA driver
<b>38114MA/W</b>	Chrome	Warm white	3000K	16W	1300lm	230V	⊕	12	Complete with 120mA driver

**38116F** | 16W | SMD 2835 | Aluminium + opal glass

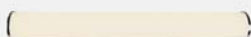

new  
IP44

A-A 38116F/C

38116F/W

Order Code	Colour	Light Colour	CCT (K)	Watts	Lumen (lm)	Input	Class		Notes
<b>38116F/C</b>	Chrome	Cool white	4000K	16W	1120lm	230V	⊕	8	Complete with 600mA driver
<b>38116F/W</b>	Chrome	Warm white	3000K	16W	1120lm	230V	⊕	8	Complete with 600mA driver

**38116P** | 16W | SMD 2835 | Aluminium + PC



new  
IP44

A-A 38116P/C

38116P/W

Order Code	Colour	Light Colour	CCT (K)	Watts	Lumen (lm)	Input	Class		Notes
<b>38116P/C</b>	Chrome	Cool white	4000K	16W	1280lm	230V	⊕	12	Complete with 120mA driver
<b>38116P/W</b>	Chrome	Warm white	3000K	16W	1280lm	230V	⊕	12	Complete with 120mA driver

Bathroom & Mirror



**38118K** | 18W | SMD 2835 | Aluminium + glass

LED BUILT IN

80 CRI

CE

2 YEAR

new

IP44



580mm

85mm

105mm



Order Code	Colour	Light Colour	CCT (K)	Watts	Lumen (lm)	Input	Class		Notes
38118K/C/C	Chrome	Cool white	4000K	18W	1225lm	230V		6	Complete with 700mA driver
38118K/MC/C	Brushed chrome	Cool white	4000K	18W	1225lm	230V		6	Complete with 700mA driver



**38118N** | 18W | SMD 2835 | Aluminium + glass

LED BUILT IN

80 CRI

CE

2 YEAR

new

IP44



580mm

105mm

115mm



Order Code	Colour	Light Colour	CCT (K)	Watts	Lumen (lm)	Input	Class		Notes
38118N/C/W	Chrome	Warm white	3000K	18W	1225lm	230V		6	Complete with 700mA driver
38118N/BBS/W	Brushed brass	Warm white	3000K	18W	1225lm	230V		6	Complete with 700mA driver



63122 | 10W | E27 | Aluminium



new  
IP20



63122/CU

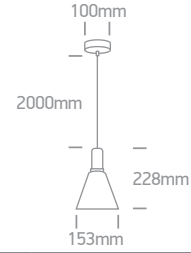

A-A+ 63122/BBS

Order Code	Colour	Watts	Input	Class		Notes
63122/BBS	Brushed brass	10W	100-240V		1	-
63122/CU	Copper	10W	100-240V		1	-



63122B | 3x10W | E27 | Aluminium



new  
IP20



63122B/CU

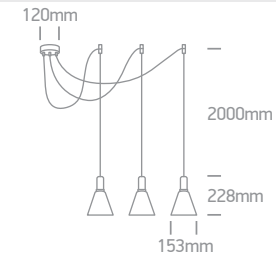

A-A+ 63122B/BBS

Order Code	Colour	Watts	Input	Class		Notes
63122B/BBS	Brushed brass	3x10W	100-240V		1	-
63122B/CU	Copper	3x10W	100-240V		1	-



63124 | 20W | E27 | Aluminium



new  
IP20



63124/BBS



63124/CU

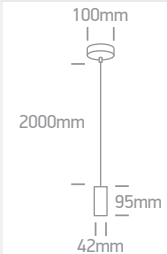

A-A+ 63124/B

Order Code	Colour	Watts	Input	Class		Notes
63124/B	Black	20W	100-240V		20	-
63124/BBS	Brushed brass	20W	100-240V		20	-
63124/CU	Copper	20W	100-240V		20	-



63124B | 3x20W | E27 | Aluminium



new  
IP20



63124B/BBS

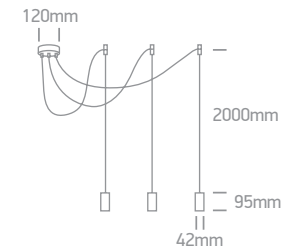

A-A+ 63124B/B

Order Code	Colour	Watts	Input	Class		Notes
63124B/B	Black	3x20W	100-240V		1	-
63124B/BBS	Brushed brass	3x20W	100-240V		1	-

Pendants

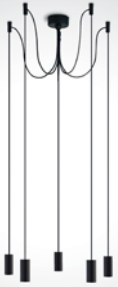

A-A+ 63124C/B

63124C | 5x20W | E27 | Aluminium



new

IP20



63124C/BBS

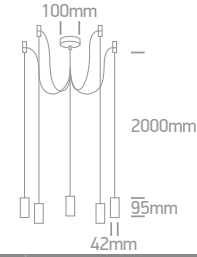

Order Code	Colour	Watts	Input	Class		Notes
63124C/B	Black	5x20W	100-240V		1	-
63124C/BBS	Brushed brass	5x20W	100-240V		1	-



A-A+ 63126/W

63126 | 20W | E27 | Aluminium

Suitable for shade or glass.



new

IP20



63126/B



63126/CU

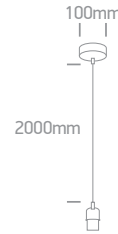

Order Code	Colour	Watts	Input	Class		Notes
63126/W	White	20W	100-240V		20	-
63126/B	Black	20W	100-240V		20	-
63126/CU	Copper	20W	100-240V		20	-



A-A+ 63126A/W

63126A | 20W | E27 | Aluminium

Suitable for shade or glass.



new

IP20



63126A/B



63126A/BBS



63126A/CU

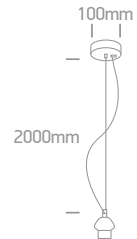

Order Code	Colour	Watts	Input	Class		Notes
63126A/W	White	20W	100-240V		20	-
63126A/B	Black	20W	100-240V		20	-
63126A/BBS	Brushed brass	20W	100-240V		20	-
63126A/CU	Copper	20W	100-240V		20	-



A-A+ 63128/BBS

63128 | 20W | E27 | Aluminium

Suitable for shade or glass.



new

IP20



63128/CU

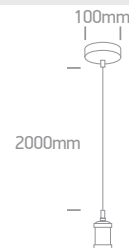

Order Code	Colour	Watts	Input	Class		Notes
63128/BBS	Brushed brass	20W	100-240V		20	-
63128/CU	Copper	20W	100-240V		20	-



B-A+ 63072/BBS

new  
IP20

63072 | 20W | E27 | Aluminium



63072/B



63072/MG

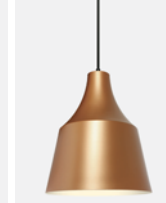

63072/CU

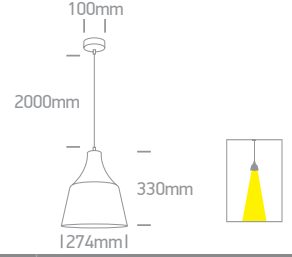

Order Code	Colour	Watts	Input	Class		Notes
63072/B	Black	20W	100-240V	⊕	1	-
63072/MG	Metal grey	20W	100-240V	⊕	1	-
63072/BBS	Brushed brass	20W	100-240V	⊕	1	-
63072/CU	Copper	20W	100-240V	⊕	1	-



B-A+ 63072A/MG

new  
IP20

63072A | 20W | E27 | Aluminium



63072A/B

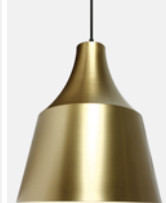

63072A/BBS

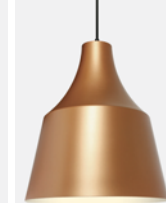

63072A/CU

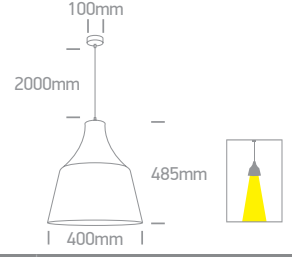

Order Code	Colour	Watts	Input	Class		Notes
63072A/B	Black	20W	100-240V	⊕	1	-
63072A/MG	Metal grey	20W	100-240V	⊕	1	-
63072A/BBS	Brushed brass	20W	100-240V	⊕	1	-
63072A/CU	Copper	20W	100-240V	⊕	1	-



B-A+ 63074/W

new  
IP20

63074 | 20W | E27 | Aluminium



63074/B 63074/MG



63074/BBS 63074/CU

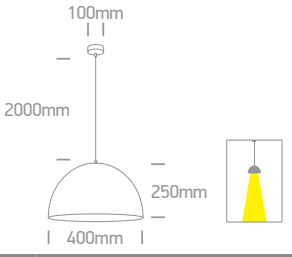

Order Code	Colour	Watts	Input	Class		Notes
63074/W	White	20W	100-240V	⊕	1	-
63074/B	Black	20W	100-240V	⊕	1	-
63074/MG	Metal grey	20W	100-240V	⊕	1	-
63074/BBS	Brushed brass	20W	100-240V	⊕	1	-
63074/CU	Copper	20W	100-240V	⊕	1	-

Decorative



**62116** | 9W | G9 | Steel

**new**  
IP20

5 YEAR



Suitable for G9 LED lamp.



300mm  
265mm



A-A+

Order Code	Colour	Watts	Input	Class		Notes
62116/BBS	Brushed brass	9W	100-240V	⊕	4	-



**62116A** | 5x9W | G9 | Steel

**new**  
IP20

5 YEAR



Suitable for G9 LED lamp.



220mm  
360mm  
300mm



A-A+

Order Code	Colour	Watts	Input	Class		Notes
62116A/BBS	Brushed brass	5x9W	100-240V	⊕	2	-



**60116** | 9W | G9 | Steel

**new**  
IP20

5 YEAR



Suitable for G9 LED lamp.



90mm  
430mm  
103mm



A-A+

Order Code	Colour	Watts	Input	Class		Notes
60116/BBS	Brushed brass	9W	100-240V	⊕	4	-



**60118** | 10W | E27 | Steel

**new**  
IP20

ADJUSTABLE  
5 YEAR



60118/B



160mm  
90mm  
140mm  
100mm



A-A+

Order Code	Colour	Watts	Input	Class		Notes
60118/B	Black	10W	100-240V	⊕	4	-
60118/BBS	Brushed brass	10W	100-240V	⊕	4	-



**63116** | 9W | G9 | Steel

**A-A<sup>++</sup>** **new** **IP20** **5 YEAR**  



Suitable for G9 LED lamp.



Order Code	Colour	Watts	Input	Class		Notes
63116/BBS	Brushed brass	9W	100-240V		4	-





**63116A** | 5x9W | G9 | Steel

**A-A<sup>++</sup>** **new** **IP20** **5 YEAR**  



Suitable for G9 LED lamp.



Order Code	Colour	Watts	Input	Class		Notes
63116A/BBS	Brushed brass	5x9W	100-240V		2	-





**63118** | 10W | E27 | Steel

**A-A<sup>++</sup>** **new** **IP20** **5 YEAR**  



Suitable for E27 LED lamp.



Order Code	Colour	Watts	Input	Class		Notes
63118/BBS	Brushed brass	10W	100-240V		4	-

Decorative



A-A+ 61116/BBS

new  
IP20

61116 | 9W | G9 | Steel

EU Schuko Plug.



61116/B

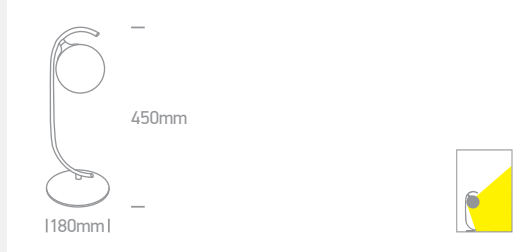

Order Code	Colour	Watts	Input	Class			Notes
61116/B	Black	9W	100-240V		150cm	4	With ON/OFF Switch
61116/BBS	Brushed brass	9W	100-240V		150cm	4	With ON/OFF Switch



A-A+ 61116A/BBS

new  
IP20

61116A | 10W | E27 | Steel

EU Schuko Plug.



61116A/B

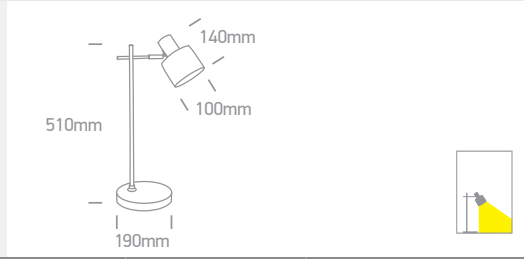

Order Code	Colour	Watts	Input	Class			Notes
61116A/B	Black	10W	100-240V		150cm	4	With ON/OFF Switch
61116A/BBS	Brushed brass	10W	100-240V		150cm	4	With ON/OFF Switch



A-A+ 61118

new  
IP20

61118 | 12W | E27 | Wood + beige fabric shade

EU Plug.

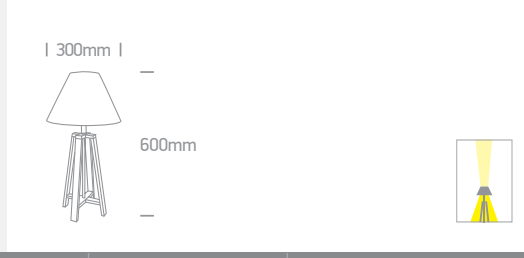

Order Code	Colour	Watts	Input	Class		Notes
61118	Wood	12W	100-240V		4	With ON/OFF Switch



A-A+ 61118A

new  
IP20

61118A | 12W | E27 | Wood + beige fabric shade

EU Plug.

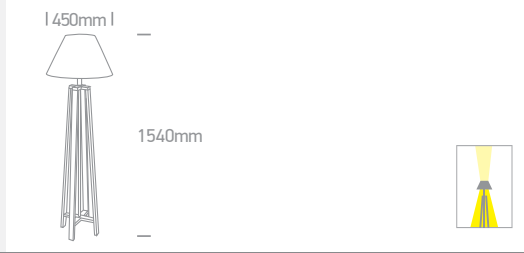

Order Code	Colour	Watts	Input	Class		Notes
61118A	Wood	12W	100-240V		1	With ON/OFF Switch





A-A+ 61086/B

new  
IP20

61086 | 12W | SMD 2835 | Steel + aluminium + acrylic

With ON/OFF Switch / EU Plug.



61086/W



61086/BS

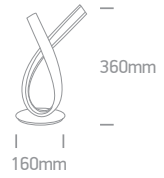

Order Code	Colour	Light Colour	CCT (K)	Watts	Lumen (lm)	Input	Class		Notes
61086/W	White	Warm white	3000K	12W	550lm	230V	□	5	Complete with 24V DC driver
61086/B	Black	Warm white	3000K	12W	550lm	230V	□	5	Complete with 24V DC driver
61086/BS	Brass	Warm white	3000K	12W	550lm	230V	□	5	Complete with 24V DC driver



A-A+ 61086A/B

new  
IP20

61086A | 29W | SMD 2835 | Steel + aluminium + acrylic

With ON/OFF Switch / EU Plug.

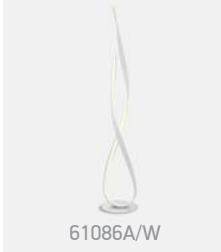

61086A/W

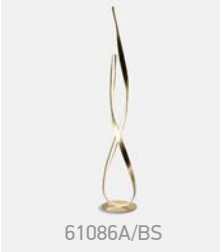

61086A/BS



Order Code	Colour	Light Colour	CCT (K)	Watts	Lumen (lm)	Input	Class		Notes
61086A/W	White	Warm white	3000K	29W	1740lm	230V	□	1	Complete with 24V DC driver
61086A/B	Black	Warm white	3000K	29W	1740lm	230V	□	1	Complete with 24V DC driver
61086A/BS	Brass	Warm white	3000K	29W	1740lm	230V	□	1	Complete with 24V DC driver



A-A+ 61082A/BR

new  
IP65

61082A | 3,3W | SMD LED | Touch switch | Dimmable | Die cast

Rechargeable USB socket.

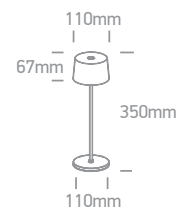
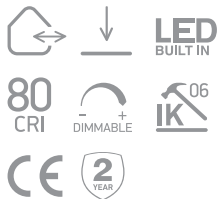

Charging time: 6Hrs  
Working time: 9Hrs



Order Code	Colour	Light Colour	CCT (K)	Watts	Lumen (lm)	Class		Notes
61082A/BR	Brown	Warm white	3000K	3,3W	200lm	◇	6	2x2200mAh lithium battery





Decorative

**63064** | 36W | SMD 2835 | Steel + aluminium



**A-A<sup>+</sup>** 63064/W

**new**  
IP20





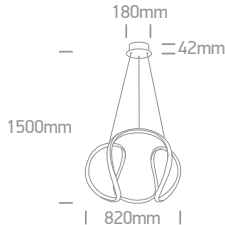



63064/B



180mm  
42mm  
1500mm  
820mm







Order Code	Colour	Light Colour	CCT (K)	Watts	Lumen (lm)	Input	Class		Notes
<b>63064/W</b>	White	Warm white	3000K	36W	1800lm	230V		1	Complete with 24V DC driver
<b>63064/B</b>	Black	Warm white	3000K	36W	1800lm	230V		1	Complete with 24V DC driver

**63066A** | 40W | SMD 2835 | Steel + aluminium



**A-A<sup>+</sup>** 63066A/W

**new**  
IP20





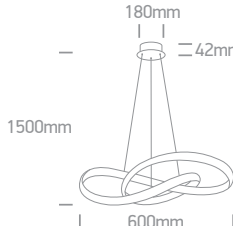



63066A/B



180mm  
42mm  
1500mm  
600mm







Order Code	Colour	Light Colour	CCT (K)	Watts	Lumen (lm)	Input	Class		Notes
<b>63066A/W</b>	White	Warm white	3000K	40W	2000lm	230V		1	Complete with 24V DC driver
<b>63066A/B</b>	Black	Warm white	3000K	40W	2000lm	230V		1	Complete with 24V DC driver

**63066** | 30W | SMD 2835 | Steel + aluminium



**A-A<sup>+</sup>** 63066/W

**new**  
IP20





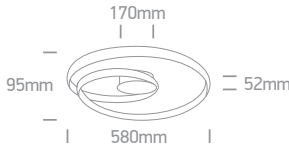



63066/B



170mm  
95mm  
52mm  
580mm



Order Code	Colour	Light Colour	CCT (K)	Watts	Lumen (lm)	Input	Class		Notes
<b>63066/W</b>	White	Warm white	3000K	30W	1500lm	230V		1	Complete with 24V DC driver
<b>63066/B</b>	Black	Warm white	3000K	30W	1500lm	230V		1	Complete with 24V DC driver



**63062** | 36W | SMD 2835 | Steel + aluminium + acrylic

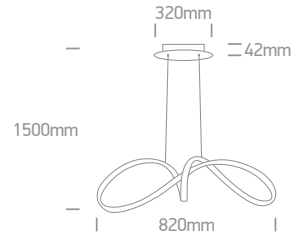

A-A<sup>+</sup>

new  
IP20

Order Code	Colour	Light Colour	CCT (K)	Watts	Lumen (lm)	Input	Class		Notes
63062/BS	Brass	Warm white	3000K	36W	1800lm	230V		1	Complete with 24V DC driver



**63068A** | 40W | SMD 2835 | Steel + aluminium + acrylic

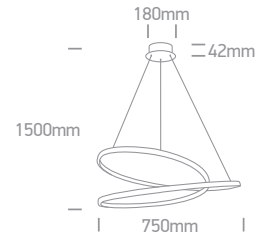

A-A<sup>+</sup>

new  
IP20

Order Code	Colour	Light Colour	CCT (K)	Watts	Lumen (lm)	Input	Class		Notes
63068A/BS	Brass	Warm white	3000K	40W	2400lm	230V		1	Complete with 24V DC driver



**63068** | 30W | SMD 2835 | Steel + aluminium + acrylic

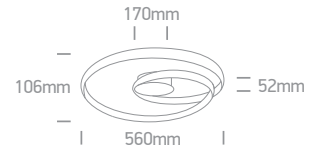

A-A<sup>+</sup>

new  
IP20

Order Code	Colour	Light Colour	CCT (K)	Watts	Lumen (lm)	Input	Class		Notes
63068/BS	Brass	Warm white	3000K	30W	1500lm	230V		1	Complete with 24V DC driver

Decorative



**63054A** | 20W | SMD 2835 | Steel + aluminium + crystal

**new**  
IP20

80 CRI CE 2 YEAR LED BUILT IN

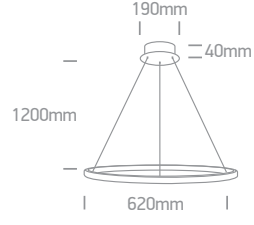
190mm  
= 40mm  
1200mm  
620mm

Order Code	Colour	Light Colour	CCT (K)	Watts	Lumen (lm)	Input	Class		Notes
63054A/B	Black	Warm white	3000K	20W	1000lm	230V		1	Complete with 24V DC driver



**63054B** | 40W | SMD 2835 | Steel + aluminium + crystal

**new**  
IP20

80 CRI CE 2 YEAR LED BUILT IN

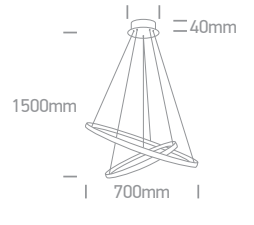
190mm  
= 40mm  
1500mm  
700mm

Order Code	Colour	Light Colour	CCT (K)	Watts	Lumen (lm)	Input	Class		Notes
63054B/B	Black	Warm white	3000K	40W	2000lm	230V		1	Complete with 24V DC driver



**63054C** | 170W | SMD 2835 | Steel + aluminium + crystal

**new**  
IP20

80 CRI CE 2 YEAR LED BUILT IN

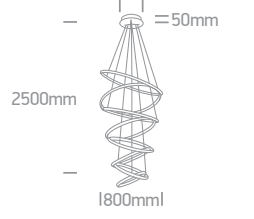
400mm  
= 50mm  
2500mm  
1800mm

Order Code	Colour	Light Colour	CCT (K)	Watts	Lumen (lm)	Input	Class		Notes
63054C/B	Black	Warm white	3000K	170W	8500lm	230V		1	Complete with 24V DC driver



**63056** | 50W | SMD 2835 | Steel + aluminium + acrylic

**new**  
IP20

80 CRI CE 2 YEAR LED BUILT IN

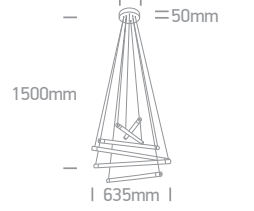
190mm  
= 50mm  
1500mm  
635mm

Order Code	Colour	Light Colour	CCT (K)	Watts	Lumen (lm)	Input	Class		Notes
63056/BBS	Brushed brass	Warm white	3000K	50W	2500lm	230V		1	Complete with 24V DC driver



**62156C** | 65W | SMD 2835 | Aluminium



**new**  
IP20

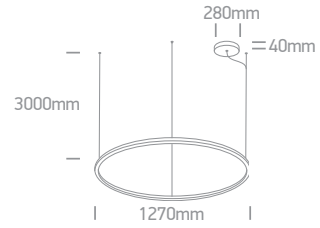

Order Code	Colour	Light Colour	CCT (K)	Watts	Lumen (lm)	Input	Class	Box	Notes
62156C/B/W	Black	Warm white	3000K	65W	4300lm	230V	⊕	1	Complete with 1600mA driver



**62156D** | 100W | SMD 2835 | Aluminium



**new**  
IP20

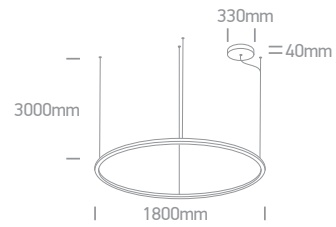

Order Code	Colour	Light Colour	CCT (K)	Watts	Lumen (lm)	Input	Class	Box	Notes
62156D/B/W	Black	Warm white	3000K	100W	6500lm	230V	⊕	1	Complete with 1200mA drivers



**63058** | 60W | SMD 2835 | Aluminium



**new**  
IP20

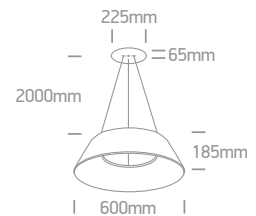

Order Code	Colour	Light Colour	CCT (K)	Watts	Lumen (lm)	Input	Class	Box	Notes
63058/BAN/W	Brushed anthracite	Warm white	3000K	60W	3600lm	230V	⊕	1	Complete with 1500mA driver
63058/BBS/W	Brushed brass	Warm white	3000K	60W	3600lm	230V	⊕	1	Complete with 1500mA driver
63058/BBR/W	Brushed brown	Warm white	3000K	60W	3600lm	230V	⊕	1	Complete with 1500mA driver



**63058A** | 80W | SMD 2835 | Aluminium



**new**  
IP20

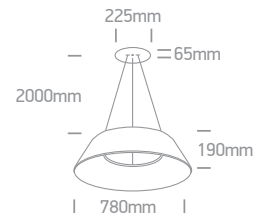

Order Code	Colour	Light Colour	CCT (K)	Watts	Lumen (lm)	Input	Class	Box	Notes
63058A/BAN/W	Brushed anthracite	Warm white	3000K	80W	4800lm	230V	⊕	1	Complete with 1050mA drivers
63058A/BBS/W	Brushed brass	Warm white	3000K	80W	4800lm	230V	⊕	1	Complete with 1050mA drivers
63058A/BBR/W	Brushed brown	Warm white	3000K	80W	4800lm	230V	⊕	1	Complete with 1050mA drivers

Wall Recessed & Inground



69012 | 3W | COB LED | Stainless steel 316

new  
IP67

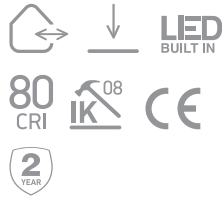

A-A++

Order Code	Colour	Light Colour	CCT (K)	Watts	Lumen (lm)	Beam Angle	Input	Class	⏏	☔	↕	📦	Notes
69012/C	Stainless steel	Cool white	4000K	3W	240lm	35°	100-240V	Ⓢ	☔	☔	↕	📦	Complete with 350mA driver



69050 | 20W | COB LED | Stainless steel 316 + tempered glass

Removable honeycomb / TRIAC Dimmable.

new  
IP67

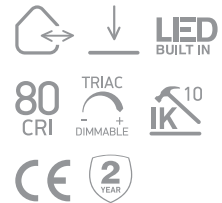

1 gland + honeycomb ring

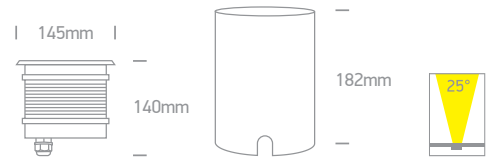

A-A++

Order Code	Colour	Light Colour	CCT (K)	Watts	Lumen (lm)	Beam Angle	Input	Class	⏏	☔	↕	📦	Notes
69050/C	Stainless steel	Cool white	4000K	20W	1800lm	25°	230V	Ⓢ	☔	☔	↕	📦	AC LED



69052 | 3W | COB LED | Stainless steel 316 + tempered glass

new  
IP67

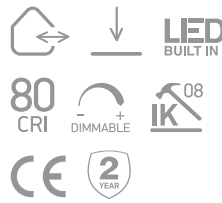

1 gland + Removable honeycomb.



A-A++

Order Code	Colour	Light Colour	CCT (K)	Watts	Lumen (lm)	Beam Angle	Input	Class	⏏	☔	↕	📦	Notes
69052/C	Stainless steel	Cool white	4000K	3W	240lm	36°	24V DC	Ⓢ	☔	☔	↕	📦	Requires 24V DC driver



69062 | 8W | SMD 2835 | Assymetrical | Stainless steel 316 + Die cast

new  
IP67

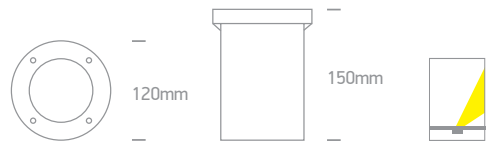
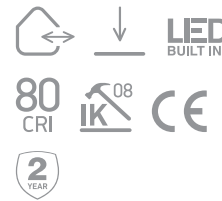

A-A++

Order Code	Colour	Light Colour	CCT (K)	Watts	Lumen (lm)	Input	Class	⏏	☔	↕	📦	Notes
69062/W	Stainless steel	Warm white	3000K	8W	180lm	230V	Ⓢ	☔	☔	↕	📦	Complete with 350mA driver



**69060** | 6W | LED | Trimless | Die cast + Glass

new  
IP67

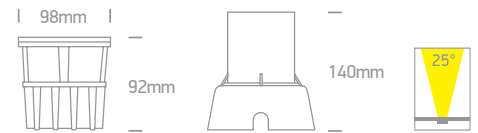
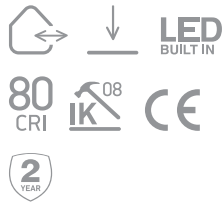

A-A++

Order Code	Colour	Light Colour	CCT (K)	Watts	Lumen (lm)	Beam Angle	Input	Class	Ⓢ	⚡	↕	📦	Notes
69060/B/W	Black	Warm white	3000K	6W	460lm	25°	100-240V	Ⓢ	⚡	⚡	↕	📦	Complete with 500mA driver



**69058A** | 6W | COB LED | Die cast

Surface mounted - No hole required.

new  
IP67

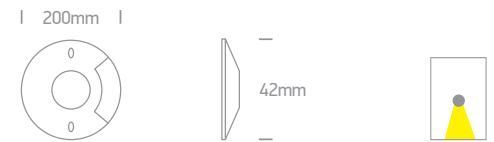
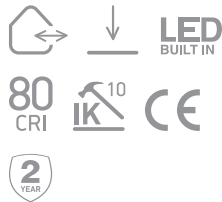

A-A++

Order Code	Colour	Light Colour	CCT (K)	Watts	Lumen (lm)	Input	Class	📦	Notes
69058A/G/W	Grey	Warm white	3000K	6W	300lm	100-240V	Ⓢ	📦	Complete with 500mA driver

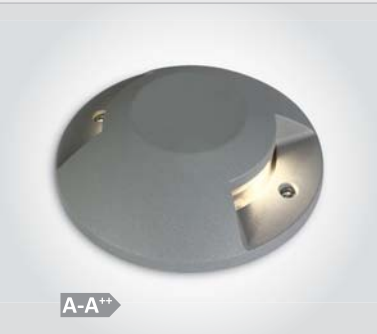

**69058B** | 2x6W | COB LED | Die cast

Surface mounted - No hole required.

new  
IP67

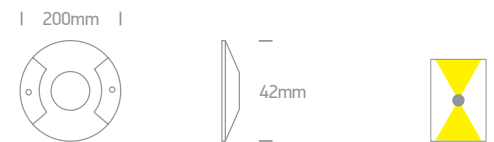
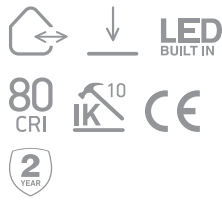

A-A++

Order Code	Colour	Light Colour	CCT (K)	Watts	Lumen (lm)	Input	Class	📦	Notes
69058B/G/W	Grey	Warm white	3000K	2x6W	600lm	100-240V	Ⓢ	📦	Complete with 500mA driver

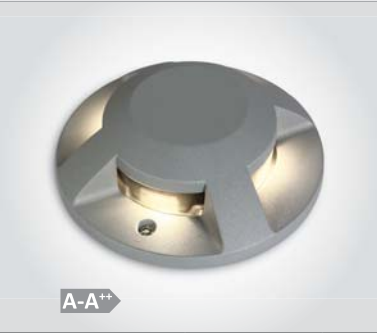

**69058C** | 4x3W | COB LED | Die cast

Surface mounted - No hole required.

new  
IP67

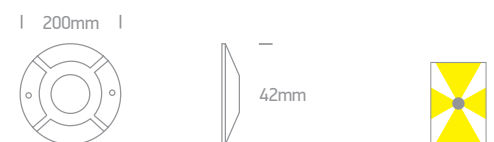
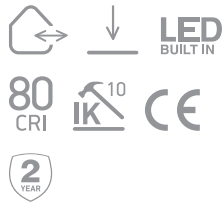

A-A++

Order Code	Colour	Light Colour	CCT (K)	Watts	Lumen (lm)	Input	Class	📦	Notes
69058C/G/W	Grey	Warm white	3000K	4x3W	600lm	100-240V	Ⓢ	📦	Complete with 300mA driver

Wall Recessed & Inground



69002A | 6x0,5W | SMD 2835 | Stainless steel 316

Decking set lights.

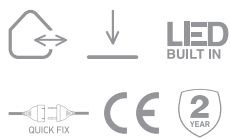

new

IP67



EU Plug with driver.

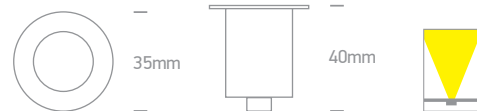

Order Code	Colour	Light Colour	CCT (K)	Watts	Lumen (lm)	Input	Class					Notes
69002A/W	Stainless steel	Warm white	3000K	6x0,5W	40lm/LED	230V		2m/2m	30mm	60mm	6	Complete with 12V DC driver





A-A++

67482 | 11W | COB LED | Adjustable beam 20°-60° | Die cast

new  
IP65

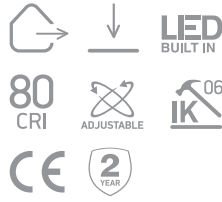

Supplied with spike.

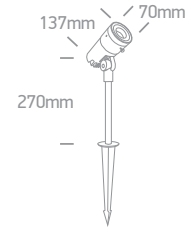

Order Code	Colour	Light Colour	CCT (K)	Watts	Lumen (lm)	Beam Angle	Input	Class	Ⓢ	📦	Notes
67482/AN/W	Anthracite	Warm white	3000K	11W	500lm	20°-60°	100-240V	Ⓢ	150cm	6	Complete with 250mA driver



A-A++

67488A | 5W | COB LED | Die cast

new  
IP65

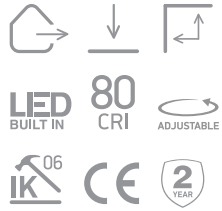

Supplied with spike.

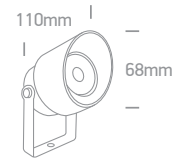

Order Code	Colour	Light Colour	CCT (K)	Watts	Lumen (lm)	Beam Angle	Input	Class	Ⓢ	📦	Notes
67488A/AN/W	Anthracite	Warm white	3000K	5W	200lm	30°	100-240V	Ⓢ	150cm	12	Complete with 350mA driver



A-A++

67488B | 11W | COB LED | Die cast

new  
IP65

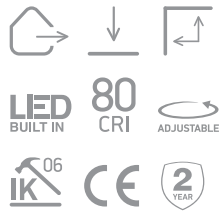

Supplied with spike.

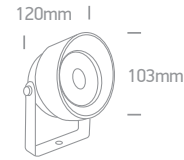

Order Code	Colour	Light Colour	CCT (K)	Watts	Lumen (lm)	Beam Angle	Input	Class	Ⓢ	📦	Notes
67488B/AN/W	Anthracite	Warm white	3000K	11W	680lm	20°	230V	Ⓢ	150cm	8	Complete with 250mA driver



A-A++

67488C | 14W | COB LED | Die cast

new  
IP65

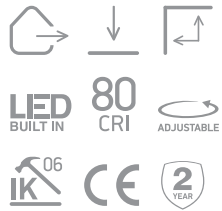

Supplied with spike.

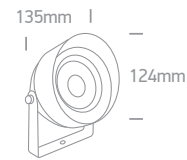

Order Code	Colour	Light Colour	CCT (K)	Watts	Lumen (lm)	Beam Angle	Input	Class	Ⓢ	📦	Notes
67488C/AN/W	Anthracite	Warm white	3000K	14W	800lm	20°	230V	Ⓢ	150cm	4	Complete with 300mA driver



**67500** | 6W | LED | Solar powered | Sensor | Aluminium 3 Modes operation.

**A-A<sup>++</sup>**

**new**  
**IP44**

80 CRI  
2 YEAR

LED BUILT IN



160mm  
170mm  
175mm



Order Code	Colour	Light Colour	CCT (K)	Watts	Lumen (lm)		Notes
67500/B/EW	Black	Extra warm white	2700K	6W	480lm	6	1x2200mAh lithium battery



**67500A** | 6W | LED | Solar powered | Sensor | Aluminium 3 Modes operation.

**A-A<sup>++</sup>**

**new**  
**IP44**

80 CRI  
2 YEAR

LED BUILT IN



160mm  
450mm



Order Code	Colour	Light Colour	CCT (K)	Watts	Lumen (lm)		Notes
67500A/B/EW	Black	Extra warm white	2700K	6W	480lm	6	1x2200mAh lithium battery



**67496** | 2W | LED | Solar powered | Sensor | Aluminium 3 Modes operation.

**A-A<sup>++</sup>**

**new**  
**IP65**

80 CRI  
2 YEAR

LED BUILT IN

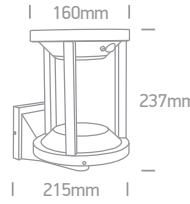
160mm  
237mm  
215mm



Order Code	Colour	Light Colour	CCT (K)	Watts	Lumen (lm)		Notes
67496/B/EW	Black	Extra warm white	2700K	2W	120lm	4	1x2200mAh lithium battery



**67496A** | 2W | LED | Solar powered | Sensor | Aluminium 3 Modes operation.

**A-A<sup>++</sup>**

**new**  
**IP65**

80 CRI  
2 YEAR

LED BUILT IN

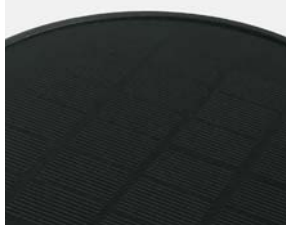
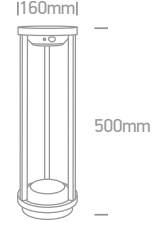
160mm  
500mm



Order Code	Colour	Light Colour	CCT (K)	Watts	Lumen (lm)		Notes
67496A/B/EW	Black	Extra warm white	2700K	2W	120lm	4	1x2200mAh lithium battery



**67490** | 6,5W | SMD LED | ABS + PC

**new**  
**IP54**

80 CRI CE 2 YEAR LED BUILT IN



1165mml  
300mm  
150mm



Order Code	Colour	Light Colour	CCT (K)	Watts	Lumen (lm)	Input	Class	Box	Notes
67490/B/W	Black	Warm white	3000K	6,5W	600lm	230V	□	6	Complete with 300mA driver

Order Code	Colour	Light Colour	CCT (K)	Watts	Lumen (lm)	Input	Class	Box	Notes
67490/B/W	Black	Warm white	3000K	6,5W	600lm	230V	□	6	Complete with 300mA driver



**67490A** | 6,5W | SMD LED | ABS + PC

**new**  
**IP54**

80 CRI CE 2 YEAR LED BUILT IN



165mm  
810mm  
150mm



Order Code	Colour	Light Colour	CCT (K)	Watts	Lumen (lm)	Input	Class	Box	Notes
67490A/B/W	Black	Warm white	3000K	6,5W	600lm	230V	□	6	Complete with 300mA driver

Order Code	Colour	Light Colour	CCT (K)	Watts	Lumen (lm)	Input	Class	Box	Notes
67490A/B/W	Black	Warm white	3000K	6,5W	600lm	230V	□	6	Complete with 300mA driver



**67494** | Bollard with 2xSchuko Sockets 1000W each | Die cast

**new**  
**IP44**

2 YEAR CE



100mm  
400mm



Order Code	Colour	Input	Class	Box	Notes
67494/AN	Anthracite	230V	⊕	4	-

Order Code	Colour	Input	Class	Box	Notes
67494/AN	Anthracite	230V	⊕	4	-



**67494A** | 3W | SMD LED | LED Bollard with 2xSchuko Sockets 1000W each | Die cast

**new**  
**IP44**

80 CRI CE 2 YEAR LED BUILT IN



100mm  
490mm

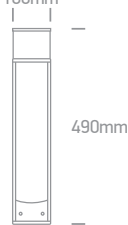

Order Code	Colour	Light Colour	CCT (K)	Watts	Lumen (lm)	Input	Class	Box	Notes
67494A/AN/W	Anthracite	Warm white	3000K	3W	240lm	230V	⊕	4	Complete with 350mA driver

Order Code	Colour	Light Colour	CCT (K)	Watts	Lumen (lm)	Input	Class	Box	Notes
67494A/AN/W	Anthracite	Warm white	3000K	3W	240lm	230V	⊕	4	Complete with 350mA driver



A-A<sup>++</sup>

69064A | 3x1W | LED | Stainless steel 316

Underwater only / 2m max depth.

new  
IP68

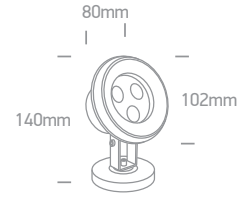
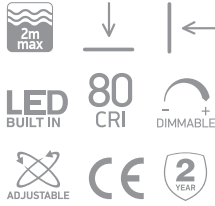

Order Code	Colour	Light Colour	CCT (K)	Watts	Lumen (lm)	Input	Class			Notes
69064A/C	Stainless steel	Cool white	4000K	3x1W	200lm	24V DC		500cm	1	Requires 24V DC driver



A-A<sup>++</sup>

69064B | 6x1W | LED | Stainless steel 316

Underwater only / 2m max depth.

new  
IP68

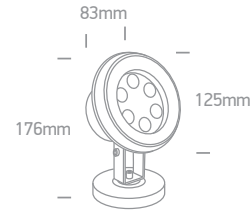
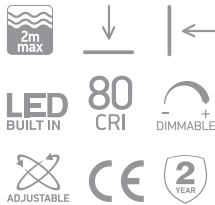

Order Code	Colour	Light Colour	CCT (K)	Watts	Lumen (lm)	Input	Class			Notes
69064B/C	Stainless steel	Cool white	4000K	6x1W	400lm	24V DC		500cm	1	Requires 24V DC driver



A-A<sup>++</sup>

69064C | 9x1W | LED | Stainless steel 316

Underwater only / 2m max depth.

new  
IP68

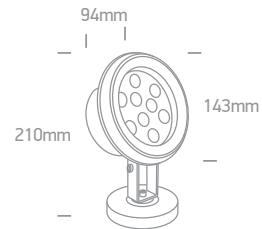
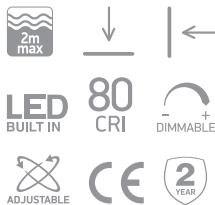

Order Code	Colour	Light Colour	CCT (K)	Watts	Lumen (lm)	Input	Class			Notes
69064C/C	Stainless steel	Cool white	4000K	9x1W	600lm	24V DC		500cm	1	Requires 24V DC driver



A-A++

**69066B** | 6x1W | LED | Stainless steel 316

Underwater only / 2m max depth.

**new**
  
**LED BUILT IN**
  
**80 CRI**
  
  
**IP68**

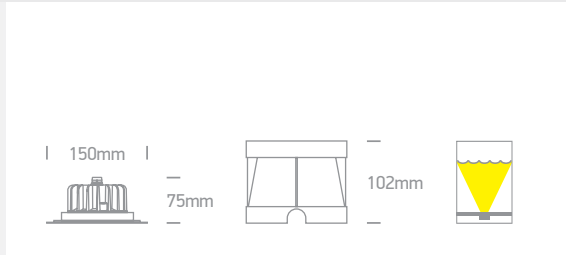

Order Code	Colour	Light Colour	CCT (K)	Watts	Lumen (lm)	Input	Class					Notes
<b>69066B/C</b>	Stainless steel	Cool white	4000K	6x1W	420lm	24V DC		500cm	140mm	110mm	10	Requires 24V DC driver



A-A++

**69066D** | 12x1W | LED | Stainless steel 316

Underwater only / 2m max depth.

**new**
  
**LED BUILT IN**
  
**80 CRI**
  
  
**IP68**

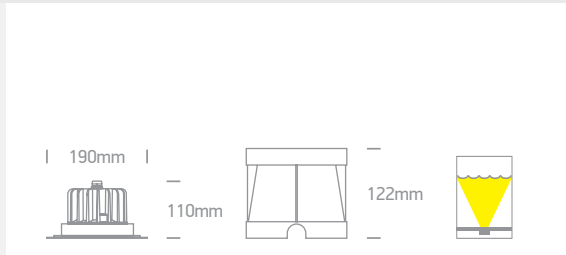

Order Code	Colour	Light Colour	CCT (K)	Watts	Lumen (lm)	Input	Class					Notes
<b>69066D/C</b>	Stainless steel	Cool white	4000K	12x1W	850lm	24V DC		500cm	175mm	130mm	10	Requires 24V DC driver

Industrial & Floodlights



**63100N** | 100W | SMD 2835 | Aluminium

**new**  
IP65

80 CRI CE 5 YEAR LED BUILT IN

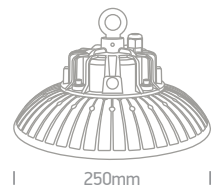
160mm  
250mm



Order Code	Colour	Light Colour	CCT (K)	Watts	Lumen (lm)	Beam Angle	Input	Class			Notes
63100N/C	Black	Cool white	4000K	100W	13000lm	90°	230V		40cm	1	Complete with 500mA driver



**63150N** | 150W | SMD 2835 | Aluminium

**new**  
IP65

80 CRI CE 5 YEAR LED BUILT IN

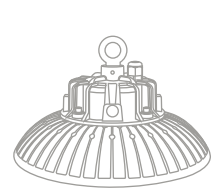
170mm  
300mm



Order Code	Colour	Light Colour	CCT (K)	Watts	Lumen (lm)	Beam Angle	Input	Class			Notes
63150N/C	Black	Cool white	4000K	150W	19500lm	90°	230V		40cm	1	Complete with 750mA driver



**63200N** | 200W | SMD 2835 | Aluminium

**new**  
IP65

80 CRI CE 5 YEAR LED BUILT IN

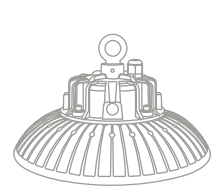
180mm  
350mm



Order Code	Colour	Light Colour	CCT (K)	Watts	Lumen (lm)	Beam Angle	Input	Class			Notes
63200N/C	Black	Cool white	4000K	200W	26000lm	90°	230V		40cm	1	Complete with 1000mA driver



**70112** | 75W | LED | Die cast

**new**  
IP66

80 CRI IK08 CE 5 YEAR LED BUILT IN



450mm  
530mm  
60mm opening



Order Code	Colour	Light Colour	CCT (K)	Watts	Lumen (lm)	Input	Class			Notes
70112/B/C	Black	Cool white	4000K	75W	9000lm	100-240V		150cm	1	Complete with 2400mA driver



**89002A** | 3W | Emergency kit with MR16 LED module | Emergency 3Hrs Maintained



**new**  
IP20

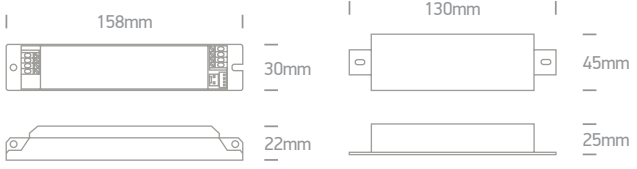

**MAINTAINED MODE**

\* Driver 89004 must be ordered separately

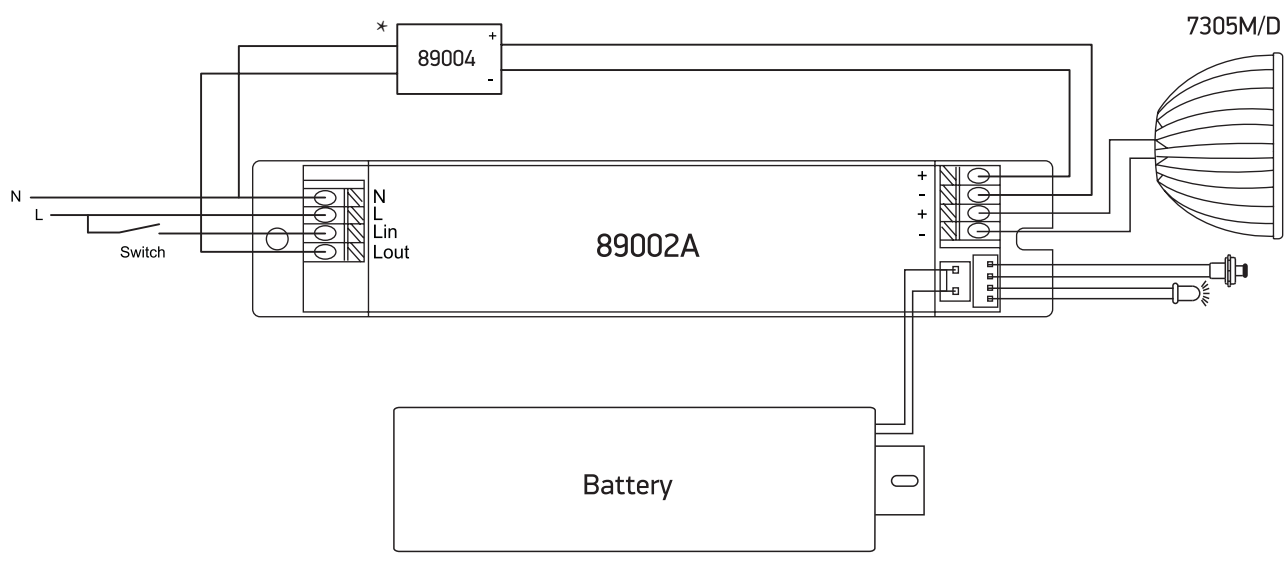

**NON-MAINTAINED MODE**

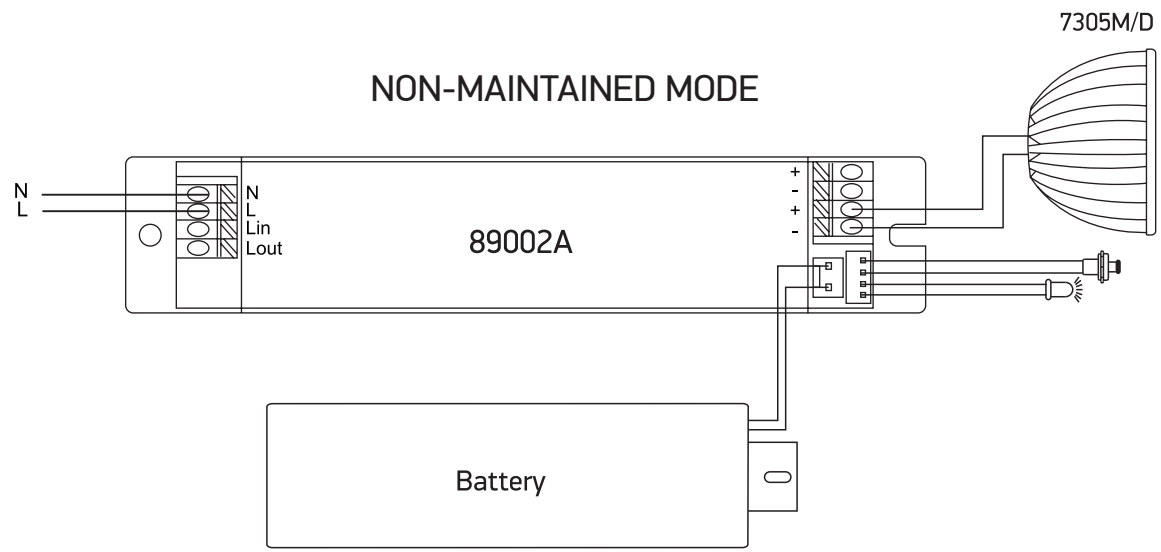

Order Code	Light Colour	CCT (K)	Watts	Input	Battery Type	Charge Period	Battery Duration	⊞	Notes
89002A	Daylight	6000K	3W	230V	Ni-Cd 4,8V 2,0Ah	24Hrs	3Hrs	24	Supplied with battery & MR16 LED module 7305M/D.

LED Drivers



**89060AR** | 1,25A | DIN RAIL Transformer 12 & 24V AC



new

IP20

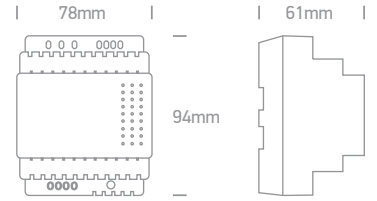

Order Code	Input	Power	Output	Class		Notes
89060AR	230V	15W@12V AC & 30W@24V AC	12V AC & 24V AC		20	-



**89060VR** | 60W | DIN RAIL driver 24V DC



new

IP20

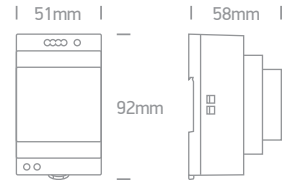

Order Code	Input	Power	Output	Class	Dimmable		Notes
89060VR	100-240V	60W	24V DC		NO	50	-



**89090VR** | 90W | DIN RAIL driver 24V DC



new

IP20

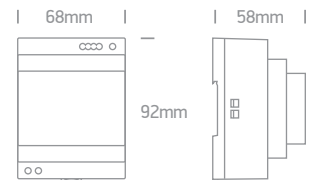

Order Code	Input	Power	Output	Class	Dimmable		Notes
89090VR	100-240V	90W	24V DC		NO	50	-





**22012** | 300W (LED) | Infrared motion sensor

**new**  
IP20

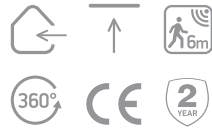

Detection Angle: 360°  
 Detection Distance: Max. 6m (<24°C)  
 Time Delay: 10sec ± 3sec to 7min ± 2 min (adjustable)  
 Ambient Light: <3-2000lux (adjustable)  
 Installation height: 2-2,4m

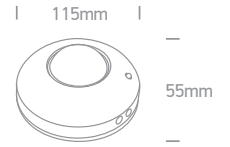

Order Code	Colour	Power	Input	Class		Notes
22012	White	300W	230V		50	-



**22014** | 1000W (LED) | Infrared presence sensor

ON when detecting presence.

**new**  
IP20



Detection Angle: 360°  
 Detection Distance: Max. 10m (<24°C)  
 Time Delay: 10sec ± 3sec to 30min ± 2 min (adjustable)  
 Ambient Light: <3-2000lux (adjustable)  
 Installation height: 2,2-6m

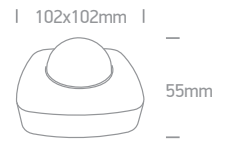

Order Code	Colour	Power	Input	Class		Notes
22014	White	1000W (LED)	230V		50	-

Accessories



**0983M** | 3-PIN Male connector + Cable

**new**

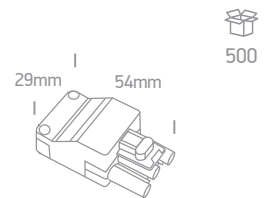
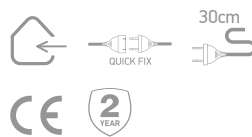

**0904MA** | 4-PIN Male connector + Cable

**new**

